

RENTER ASSISTANCE GUIDE



SMOKING POLICY

Smoking is not allowed inside Cruise America/Cruise Canada motorhomes. Housekeeping charges up to \$250 may be applied at time of return if the vehicle smells of cigarette or cigar smoke. Please be considerate of others. Thank you for not smoking!



TABLE OF CONTENTS

2 THE MOTORHOME CAB

- 2 Warning Lights
- 4 Warning Chimes and Buzzers
- 4 Gauges
- 5 Controls
- 6 Heating, Ventilation and Air Conditioning Control
- 7 Seats and Seatbelts
- 7 Ignition Switch

9 DRIVING & ROAD RULES

- 9 Safe Driving
- 9 Preparing to Start Your Vehicle
- 10 Driving Your Motorhome
- 11 Driving Using the Gearshift
- 12 Safe Driving Tips

15 ACCIDENTS, SERVICE & MAINTENANCE

17 SAFETY EQUIPMENT

- 17 Smoke Detector, Fire Extinguisher, L.P. Gas Leak Detector
- 18 Carbon Monoxide Detector

19 CAMPGROUND TIPS & VEHICLE SPECIFICATIONS

- 19 Arriving at the Campground
- 19 Electrical Hook Up
- 19 Water Hook Up
- 19 Sewer Hook Up
- 20 Campground Etiquette
- 21 Typical Vehicle Specifications
- 22 Monitor Panel

23 ELECTRICAL SYSTEM

- 23 12-Volt
- 23 120-Volt
- 24 Power Converter
- 25 Generator

28 120-VOLT APPLIANCES

- 28 The Microwave Oven
- 29 The Roof Air Conditioner

31 THE L.P. GAS SYSTEM

- 31 L.P. Gas System
- 31 L.P. Gas Leak Detector
- 33 The Refrigerator
- 35 The Stovetop (Range)
- 36 The Furnace
- 38 The Water Heater

41 THE WATER SYSTEM

- 41 The Fresh Water System
- 43 The Waste Water System
- 43 The Motorhome Toilet

45 WINTER OPERATIONS

47 TROUBLESHOOTING INDEX

57 RETURNING THE MOTORHOME

PREFACE

Thank you for selecting Cruise America, the leading RV rental and sales company serving the United States and Canada.

This manual is intended to assist you in the operation of the RV to ensure your travels will be as carefree as possible. The material contained in this manual is intended as a guide only. If you experience any problems at all during your rental, please see the Troubleshooting Index on page 47. You can often save yourself the time of a phone call by simply flipping to the back of this book for most problems.

Cruise America and Cruise Canada purchase motorhomes from several different manufacturers and the fleet consists of several different model years with different chassis manufacturers. Each model year brings changes. Therefore, it is impossible to provide a single authoritative manual to cover all motorhome variations. The manual specifically addresses late model year motorhomes built on Ford chassis.

AS A REMINDER, IF FURTHER ASSISTANCE IS NEEDED, CALL TRAVELER'S ASSISTANCE: 1-800-334-4110

- If at any time during your travels you develop the need for service, please have this copy of the Renter's Guide for reference when you call.
- If you are involved in an accident of any type you must call the Traveler's Assistance Department as soon as possible within 24 hours and provide all the details of the accident, including location, police report, injuries, and any other information requested by the Traveler's Assistance Representative. (see page 15)
- When you call please have your contract number ready. It will help in handling your concern. The contract number can be found at the top of your "Rental Agreement" or "Rental Contract". It is listed as "RA# _____".

RA#: PHX13468

RENTAL CONTRACT: CHECK-OUT		LESSOR: CRUISE AMERICA/CRUISE CANA	REF: J07443																																																								
RENTAL INFORMATION Location: CRUISE AMERICA Address: 11 WEST HAMPTON AVE. City, St, Zip: WEA (WA), WA 98210 Telephone: 480-464-7384 Date/Time Out: 04/15/2013 1521 Passengers: 2		RENTAL INFORMATION CRUISE AMERICA 12201 HIGHWAY EVERETT (SEA) 425-355-8933 05/20/2013																																																									
RENTER INFORMATION Name: JOHN DOE Address: SCHOEN 132 Address 2: City: Berlin State, Zip: DE 19124 Telephone: 49620786142 Driver License: 49620786142 Cell Ph: 49620786142		AUTHORIZED DRIVER: JOHN DOE 02-26-2028 03-31-1975																																																									
VEHICLE INFORMATION: Product: C25 /C25 /GROSS Max Capacity: 5 UNIT NUMBER: 251128 License #: 5175KX Class/Class: C25 /C25 Gen. Use Out: 278.0 Fuel Level: 3/8 Mileage Out: 87428 Camper #:		GENERAL INFORMATION SUPPLEMENTAL LIABILITY INSURANCE (S.L.I.) By initial customer acceptance or decline S.L.I. and agree to pay the daily rate indicated in the left column. Customer acknowledges receipt of information describing terms and conditions, contained in the Additional Terms & Conditions of Rental Contract.																																																									
ESTIMATED CHARGES <table border="1"> <tr><td>Hours</td><td>(0)</td><td>0 8 25.00</td><td>0.00</td></tr> <tr><td>Days</td><td>(0)</td><td>0 8 38.00</td><td>0.00</td></tr> <tr><td>Nights</td><td>(5)</td><td>0 8 411.00</td><td>0.00</td></tr> <tr><td>GROSS RATE*</td><td>(5)</td><td>0 8 411.00</td><td>0.00</td></tr> <tr><td>Mileage</td><td>(6000)</td><td>0 8 0.34</td><td>0.00</td></tr> <tr><td>Drop</td><td></td><td></td><td>350.00</td></tr> <tr><td>SD</td><td>(12)</td><td>0 8 0.000</td><td>0.00</td></tr> <tr><td>SDS</td><td>(0)</td><td>35 8 15.760</td><td>511.25</td></tr> <tr><td>PROHIBDISC</td><td>(0)</td><td>35-815.7850</td><td>-511.25</td></tr> <tr><td>CS</td><td>(0)</td><td>0 8 3.500</td><td>0.00</td></tr> <tr><td>PPHOP</td><td>(0)</td><td>1 8 35.000</td><td>35.00</td></tr> <tr><td>PPHOP</td><td>(0)</td><td>1 8 35.000</td><td>35.00</td></tr> <tr><td>CS</td><td>(0)</td><td>2 8 8.500</td><td>17.00</td></tr> <tr><td>Fuel Charge</td><td>(0)</td><td>0 8 6.00(9)</td><td>0.00</td></tr> </table>		Hours	(0)	0 8 25.00	0.00	Days	(0)	0 8 38.00	0.00	Nights	(5)	0 8 411.00	0.00	GROSS RATE*	(5)	0 8 411.00	0.00	Mileage	(6000)	0 8 0.34	0.00	Drop			350.00	SD	(12)	0 8 0.000	0.00	SDS	(0)	35 8 15.760	511.25	PROHIBDISC	(0)	35-815.7850	-511.25	CS	(0)	0 8 3.500	0.00	PPHOP	(0)	1 8 35.000	35.00	PPHOP	(0)	1 8 35.000	35.00	CS	(0)	2 8 8.500	17.00	Fuel Charge	(0)	0 8 6.00(9)	0.00	ACCEPTS _____ DECLINES _____ The valid and collectible liability insurance and personal injury protection insurance of any authorized rental or leasing driver is primary for the limits of liability and personal injury protection coverage required by ss. 324.02(1)(7) and 427.736, Florida Statutes. I acknowledge receipt of and have read and agree to the terms of "PAGE A" and the ADDITIONAL TERMS AND CONDITIONS and agree thereto. Operation of vehicle by unauthorized operators voids all insurance coverages and waivers. All parking/traffic fines are payable at check in. THERE ARE NO RETURNS FOR EARLY RETURNS/UNUSED MILES EXCEPT UNUSED SUPPLEMENTAL MILEAGE CHARGES Cardholder (s) acknowledges receipt of goods and/or services the amount of the total charges shown herein and agree to perform the obligations set forth in the cardholder's agreement with the LESSOR. * JOHN DOE JOHN DOE	
Hours	(0)	0 8 25.00	0.00																																																								
Days	(0)	0 8 38.00	0.00																																																								
Nights	(5)	0 8 411.00	0.00																																																								
GROSS RATE*	(5)	0 8 411.00	0.00																																																								
Mileage	(6000)	0 8 0.34	0.00																																																								
Drop			350.00																																																								
SD	(12)	0 8 0.000	0.00																																																								
SDS	(0)	35 8 15.760	511.25																																																								
PROHIBDISC	(0)	35-815.7850	-511.25																																																								
CS	(0)	0 8 3.500	0.00																																																								
PPHOP	(0)	1 8 35.000	35.00																																																								
PPHOP	(0)	1 8 35.000	35.00																																																								
CS	(0)	2 8 8.500	17.00																																																								
Fuel Charge	(0)	0 8 6.00(9)	0.00																																																								
TOTAL CHARGES ----- \$ 1012.60 METHOD OF PAYMENT PER 04/15/2013 VI*****6114 064223 12/2015		TOTAL DUE ----- 0.00 CHECK-OUT EMPLOYEE: PER15 Print #: 2 PAGE A																																																									

RENTAL AGREEMENT NUMBER LOCATION

THE MOTORHOME CAB

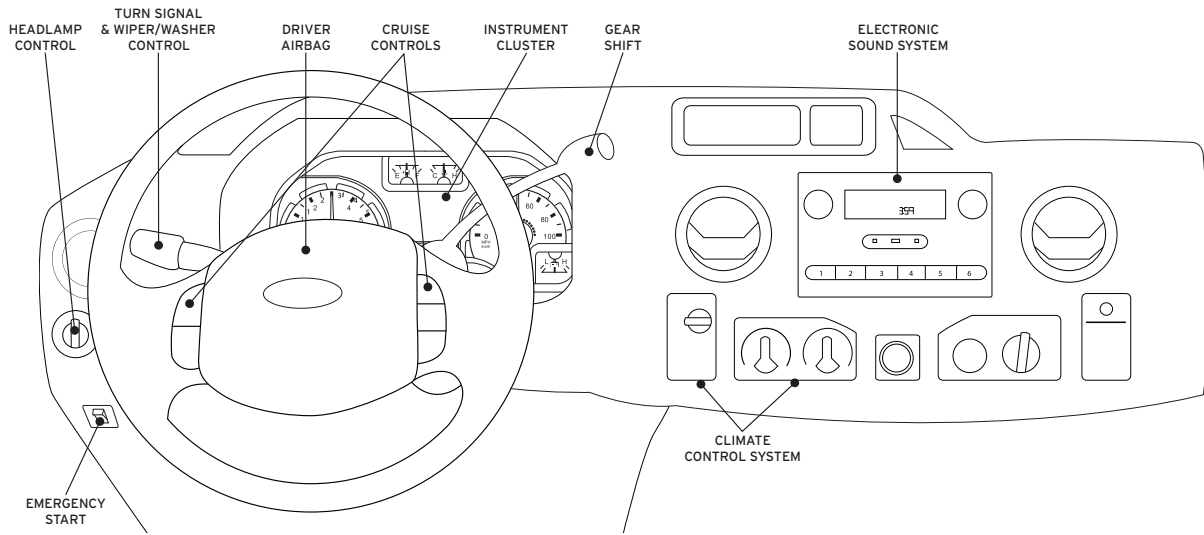

WARNING LIGHTS

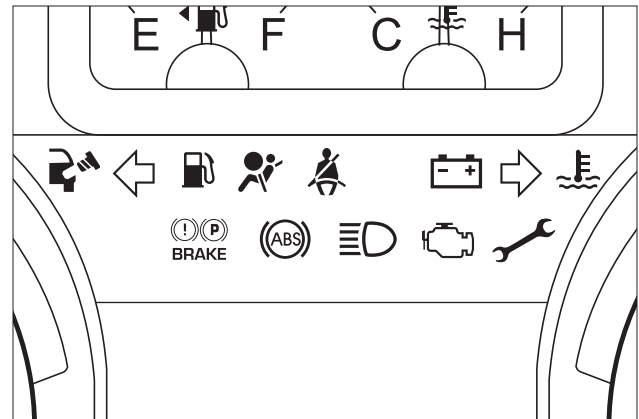
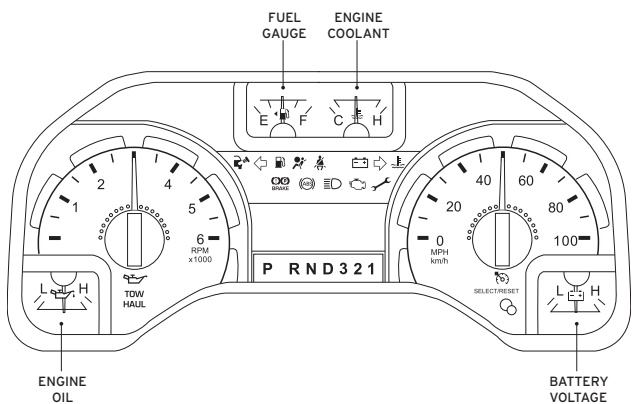

ENGINE COOLANT TEMPERATURE

Illuminates when the engine coolant temperature is high. Stop the vehicle as soon as possible, turn off the engine and let it cool.



AIR-BAG READINESS

Comes on momentarily when the ignition is turned to the **ON** position. If the light fails to illuminate, continues to flash, or remains on, call Traveler's Assistance.



ELECTRONIC THROTTLE CONTROL

Illuminates when engine is in reduced power or "limp home" mode. Call Traveler's Assistance.



TOW HAUL (SEE ALSO P. 4)

Illuminates when Tow/Haul is active. If light flashes steadily, call Traveler's Assistance immediately.

TOW HAUL

CHECK FUEL CAP

Illuminates when fuel cap may not be properly installed. May also cause the Service Engine Soon (SES) light to illuminate.



SPEED CONTROL (CRUISE CONTROL)

Illuminates when the speed control (cruise control) is activated.



HIGH BEAMS

Illuminates when the high beam headlamps are turned on.



ANTI-LOCK BRAKE SYSTEM (ABS)

If the light remains on or flashes continuously, call Traveler's Assistance. With the ABS light on, the anti-lock brake system is disabled and normal braking is still effective unless the brake warning light also remains illuminated with the parking brake released.



SERVICE ENGINE SOON (SES)

SES LIGHT IS CONTINUOUSLY LIT:

A continuously lit SES light means that one of the engine's emission control systems may be malfunctioning. The malfunction may be a temporary condition. Examples of temporary conditions which may cause the SES light to illuminate are:

1. The vehicle has run out of fuel. (The engine may misfire or run poorly.)
2. Poor fuel quality or water in the fuel.
3. The fuel cap may not have been properly installed and securely tightened.

Filling the fuel tank with good quality fuel and/or properly installing and securely tightening the gas cap can correct temporary malfunction. After three driving cycles without these or any other temporary malfunctions present, the SES light should turn off. (A driving cycle consists of a cold engine startup followed by mixed city/highway driving.) No additional service is required.

If the Service Engine Soon light remains on after 3 engine cycles, contact Traveler's Assistance.

SES LIGHT IS FLASHING:

A flashing SES light means the engine is misfiring. Drive in a moderate fashion (avoid heavy acceleration) and contact Traveler's Assistance as soon as possible.



LOW FUEL

Illuminates when the fuel tank is empty or almost empty.



SAFETY BELT

Momentarily illuminates when the ignition is turned to the **ON** position to remind you to fasten your safety belts.



CHARGING SYSTEM

Illuminates when the ignition is turned to the **ON** position and the engine is off. If this light illuminates when the engine is running, call Traveler's Assistance.



BRAKE SYSTEM WARNING

Illuminates if the parking brake is engaged. If illuminated with the parking brake released indicates low brake fluid level and the brake system should be inspected immediately. Call Traveler's Assistance.



DIRECTIONAL INDICATORS

Illuminates when the left or right turn signal or the hazard lights are turned on. If one or both of the indicators stay on continuously, check for a burned-out turn signal bulb.



ENGINE OIL

Illuminates when the engine oil pressure is low. Add engine oil as soon as possible. Use 5W-20 engine oil if available. If 5W-20 is unavailable, you may use 5W-30. If oil light illuminates again, call Traveler's Assistance.



Troubleshooting the ABS and Brake Warning Lights

PROBLEM	POSSIBLE CAUSES	CHECKS/SOLUTIONS
ABS light and Brake light are both lit	<ol style="list-style-type: none"> 1. Speed sensor malfunction 2. Combination ABS problem plus parking brake on or low brake fluid 	<ol style="list-style-type: none"> 1. Call Traveler's Assistance immediately 2. Release parking brake or check and fill brake fluid and call Traveler's Assistance to schedule a repair.
ABS light flashing or stays lit	Anti-lock brake system is disabled and normal braking is still effective	Call Traveler's Assistance to schedule repair.
Brake light is lit	<ol style="list-style-type: none"> 1. Parking brake may be on 2. Low on brake fluid 	<ol style="list-style-type: none"> 1. Release parking brake 2. Call Traveler's Assistance to schedule repair.

TOW/HAUL LIGHTS

For mountain driving conditions, select the “Tow-Haul” option on the gearshift. The vehicle will then automatically slow down descending hills so you don’t have to ride the brakes. Just press the button on the end of the gearshift to turn it on and off.

There will be either

1. A Tow/Haul Light and Button on the gearshift, or
2. A Tow/Haul Light below the oil pressure gauge and a Tow/Haul Button on the gearshift (see illustrations to the right).

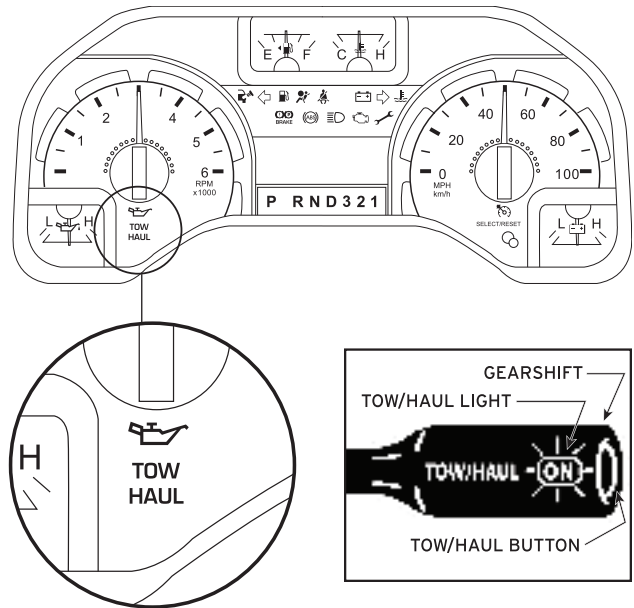

WARNING CHIMES AND BUZZERS

SAFETY BELT WARNING CHIME/BUZZER

Sounds to remind you to fasten your safety belts.

KEY-IN-IGNITION WARNING CHIME/BUZZER

Sounds when the key is in the ignition in the **OFF/LOCK** or **ACC** position and the driver’s door is opened.

HEADLAMPS ON WARNING CHIME

Sounds when the headlamps or parking lamps are on, the ignition is off (and the key is not in the ignition) and the driver’s door is opened.

PARKING BRAKE ON WARNING CHIME

Sounds when the parking brake is set, the engine is running and the vehicle is moving at 3 mph or more.

GAUGES

ENGINE OIL PRESSURE GAUGE

Shows the engine oil pressure. Sufficient pressure exists as long as the needle remains in the normal range (the area between the “L” and “H”). If the gauge indicates low pressure, stop the vehicle as soon as safely possible and switch off the engine immediately. Check the oil level. Add oil if needed. If, however, the oil level is correct, contact Traveler’s Assistance.



FUEL GAUGE

Displays approximately how much fuel is in the fuel tank when the key is in the **ON** position. The fuel gauge may vary slightly when the vehicle is in motion. The ignition should be in the **OFF** position while the vehicle is being refueled. When the gauge first indicates empty, there is a small amount of reserve fuel in the tank. When refueling the vehicle from an empty indication, the amount of fuel that can be added will be less than the advertised capacity due to the reserve fuel.



ENGINE COOLANT TEMPERATURE GAUGE

Indicates the temperature of the engine coolant. At normal operating temperature, the needle remains within the normal area (the area between “H” and “C”). If it enters the red section, the engine is overheating. Stop the vehicle as soon as safely possible, switch off the engine immediately and let the engine cool. Never remove the coolant reservoir cap while the engine is running or hot. The gauge indicates the temperature of the engine coolant, not the coolant level. If the coolant is not at its proper level the gauge indication will not be accurate. If the gauge enters the red section, the engine coolant and Service Engine Soon indicators illuminate.



BATTERY VOLTAGE GAUGE

Shows the battery voltage when the ignition is in the **ON** position. If the pointer moves and stays outside the normal operating range, have the vehicle’s electrical system checked as soon as possible.



CONTROLS

HEADLAMP CONTROL

The headlamp control is located on the dash, left of the steering column. Pull it toward you to the first position to turn on the parking lamps, tail lamps, license plate lamps and marker lamps. Pull the headlamp control toward you to the outer position to turn on the headlamps in addition to the previous lamps.

REMINDER: TURN HEADLAMPS OFF WHEN YOU TURN THE ENGINE OFF.

DAYTIME RUNNING LAMPS

This vehicle may be equipped with daytime running lamps. If so, it turns on the headlamps with a reduced output provided the ignition switch is in the ON position and the headlamp control is in the OFF or Parking lamps position.

Always remember to turn on your headlamps at dusk or during inclement weather. The Daytime Running Lamp System does not activate your tail lamps and generally may not provide adequate lighting under these conditions. Failure to activate your headlamps under these conditions may result in a collision.

HIGH BEAM CONTROL

High beam control is located at the end of the turn signal lever on the left of the steering column. Push forward to activate and pull toward you to deactivate.

PANEL DIMMER CONTROL

The instrument panel dimmer control is built into the headlamp switch on the dash. Rotate the knob clockwise/ counterclockwise when the headlamp control is in the parking lamp or low beam position. To turn on the courtesy lamp, rotate this knob fully counterclockwise.

HAZARD FLASHER SWITCH

The hazard flasher, also called the emergency flasher or four-way flasher, is controlled from a switch located on the top of the steering column. Use this only in an emergency to warn traffic of a vehicle breakdown, approaching danger, etc. The hazard flashers can be operated when the ignition is off. Depress the control to activate all hazard flashers simultaneously. Depress the control again to turn the flashers off.

SPEED CONTROL (CRUISE CONTROL)

All of the controls are located on the center section of the steering wheel. Do not use the speed control in heavy traffic or on roads that are winding, slippery, or unpaved. Do not shift the gearshift lever into neutral with the speed control on. On the left side are the ON/OFF controls. Press the **ON** switch to engage. Note that the vehicle speed must be at least 30 miles per hour for the speed control to begin.

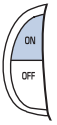

To turn the speed control off, press **OFF**. Once the speed control is switched off, the previously programmed set speed will be erased. The remainder of the speed control switches are located on the right side of the steering wheel.

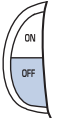

To set a speed, press **SET ACCEL**.

If you drive up or down a steep hill, your speed may vary momentarily slower or faster than the set speed. This is normal.

Speed control cannot reduce the vehicle speed if it increases above the set speed on a downhill. If your vehicle speed is faster than the set speed while driving on a downhill, you may want to shift to the next lower gear or apply the brakes to reduce your vehicle speed.

To set a higher speed, press and hold **SET ACCEL**. Release the control when the desired vehicle speed is reached. Or you may repeatedly press and release **SET ACCEL**. Each press will increase the set speed by 1 mile per hour or accelerate with your accelerator pedal. When the desired vehicle speed is reached, press and release **SET ACCEL**.



You can accelerate with the accelerator pedal at any time during speed control usage. Releasing the accelerator pedal will return your vehicle to the previously programmed set speed.

To set a lower set speed, press and hold **COAST**. Release the control when the desired speed is reached. Or you may repeatedly press and release **COAST**.



Each press will decrease the set speed by 1 mile per hour or depress the brake pedal. When the desired vehicle speed is reached, press **SET ACCEL**.

To disengage the speed control, depress the brake pedal. Disengaging the speed control will not erase the previously programmed set speed. Pressing **OFF** will erase the previously programmed set speed.

To return to a previously set speed, press **RES**. For **RES** to operate, the vehicle speed must be faster than 30 miles per hour. If your vehicle slows down more than 10 miles per hour below your set speed on an uphill, your speed control will disengage. This is normal. Pressing **RES** will re-engage it.



DIRECTIONAL INDICATORS

Push down to signal a left turn. Push up to signal a right turn.

WINDSHIELD WIPER/ WASHER CONTROL

The windshield wiper/washer control is located at the end of the turn signal arm on the left side of the steering column. Rotate the windshield wiper control to the desired interval, low or high speed position.

The bars of varying lengths on the turn signal arm are for intermittent wipers. When in this position, rotate the control upward for fast intervals and downward for slow intervals.

Push the control on the end of the turn signal arm to activate washer. Push and hold for a longer wash cycle. The washer will automatically shut off after ten seconds of continuous use.

HEATING, VENTILATION AND AIR CONDITIONING CONTROL

FAN CONTROL

Controls the volume of air circulated in the vehicle.

TEMPERATURE CONTROL KNOB

Controls the temperature of the airflow inside the vehicle when the mode selector is set on heater or air conditioner.

MODE SELECTOR CONTROL

Controls the direction of the airflow to the inside of the vehicle and it allows selection of the heater, vent, or air conditioner. In the OFF setting outside air is shut out and the fan will not operate. For short periods of time only, use this mode to prevent undesirable odors from entering the vehicle.

MAX A/C uses recirculated air to cool the vehicle. MAX A/C is noisier than NORM A/C and will cool the inside of the vehicle faster. Airflow will be from the instrument panel registers. This mode can also be used to prevent undesirable odors from entering the vehicle.

NORM A/C uses outside air to cool the vehicle. It is quieter than MAX A/C. Airflow will be from the instrument panel registers.

VENT distributes outside air through the instrument panel registers. However, the air will not be cooled below the outside temperature because the air conditioning does not operate in this mode.

FLR allows for maximum heating by distributing outside air through the floor ducts. However, the air will not be cooled below the outside temperature because the air conditioning does not operate in this mode.

MIX distributes outside air through the windshield defroster ducts and the floor ducts. Heating and air conditioning capabilities are provided in this mode. For added customer comfort, when the temperature control knob is anywhere in

between the full hot and full cold positions, the air distributed through the floor ducts will be slightly warmer than the air sent to the windshield defroster ducts. If the temperature is about 10 degrees C (50 degrees F) or higher, the air conditioner will automatically dehumidify the air to reduce fogging.

DEF distributes outside air through the windshield defroster ducts. It can be used to clear ice or fog from the windshield. If the temperature is about 10 degrees C (50 degrees F) or higher, the air conditioner will automatically dehumidify the air to reduce fogging.

Operating tips:

In humid weather, select defroster before driving. This will reduce fogging on your windshield. After a few minutes, select any desired position. To prevent humidity buildup inside the vehicle, do not drive with the climate control system in the **OFF** position.

Remove any snow, ice or leaves from the air intake area at the bottom of the windshield. If the vehicle has been parked with the windows closed during hot weather, the air conditioner will do a much faster job of cooling if you drive for two or three minutes with the windows open. This will force most of the hot, stale air out of the vehicle. Then operate your air conditioner as you would normally.

Do not place objects over the defroster outlets. These objects can block airflow and reduce your ability to see through the windshield. Also, avoid placing small objects on top of your instrument panel. These objects can fall down into the defroster outlets and block airflow and possibly damage the climate control system.

SEATS AND SEAT BELTS

(SAFETY RESTRAINTS)

There are two adjustments which may be made to the driver and passenger seats. Lift the handle on the front of the seat to move the seat forward or backward. Pull the lever located on the side of the seat next to the door to adjust the seatback.

NEVER ADJUST THE DRIVER'S SEAT OR SEATBACK WHEN THE VEHICLE IS MOVING.

Always drive and ride with your seatback upright and the lap belt low across the hips.

Reclining the seatback can reduce the effectiveness of the seat's safety belt in the event of a collision.

The driver and passenger seats are equipped with a combination lap and shoulder belt. To use, insert the belt tongue into the proper buckle until you hear a snap and feel it latch. The proper buckle is the one that is closest to the direction the tongue is coming from. Make sure the tongue is securely fastened in the buckle.

To unfasten, push the release button and remove the tongue from the buckle.

SAFETY BELT PRETENSIONER

The vehicle is equipped with safety belt pretensioners at the driver and front passenger seating positions.

The safety belt pretensioner is a device which removes excess webbing from the safety belt system. The safety belt pretensioner uses the same crash sensor system as the front air bag supplemental restraint system. When the safety belt pretensioner deploys, webbing from the lap and shoulder belt is tightened.

SAFETY BELT HEIGHT ADJUSTMENT

The vehicle has safety belt height adjustments for the driver and front passenger. Adjust the height of the shoulder belt so the belt rests across the middle of your shoulder.

To lower the shoulder belt height, push the button and slide the height adjuster down. To raise the height of the shoulder belt, slide the height adjuster up. Pull down on the height adjuster to make sure it is locked in place.

Position the shoulder belt height adjuster so that the belt rests across the middle of your shoulder. Failure to adjust the safety belt properly could reduce the effectiveness of the safety belt and increase the risk of injury in a collision.

IGNITION SWITCH

The ignition switch has five positions. Note that the positions are not marked.

ACCESSORY allows the electrical accessories such as the radio to operate while the engine is not running.

PARK locks the steering wheel, automatic transmission gearshift lever and allows key removal.

OFF shuts off the engine and all accessories without locking the steering wheel.

ON all electrical circuits operational. Warning lights illuminated. Key position when driving.

START cranks the engine. Release the key as soon as the engine starts.

TILT STEERING

The motorhome is equipped with a tilt steering wheel. The control is a small stalk located under the steering wheel to the left. Just pull the tilt steering control toward you to move the steering wheel up or down. Hold the control while adjusting the wheel to the desired position, then release the control. Never adjust the steering wheel when the vehicle is moving.

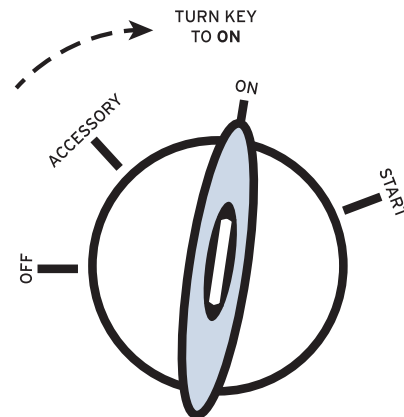

DRIVING & ROAD RULES

SAFE DRIVING

BEFORE DRIVING AWAY

Note: Do not let anyone else drive the motorhome. Only the renter and those listed on the Rental Agreement as additional drivers are authorized to operate the motorhome. The renter is fully responsible for any and all damage caused by an unauthorized driver.

Before getting into the driver's seat always observe the area around your motorhome. A car, bicycle, child or tree branch may be behind, near the top or beside your vehicle and remain unseen until it's too late. There are a few blind spots you absolutely must check when parking or backing up.

Before starting the engine, take a walk around the inside and the outside of the vehicle.

BE SURE THAT:

- The shore line is plugged into the receptacle inside the shore line compartment.
- All compartment doors are latched or locked.
- Nothing is left behind.
- Fresh water hose and dump hose are disconnected and stored
- You check the fresh water supply. Be sure that you have enough water to reach your destination.
- There is no evidence of fluid leaks under the vehicle.
- Roof vents are closed.
- The refrigerator door is latched.
- Cabinet doors and drawers are closed.
- Coach entry door is closed **AND DEADBOLT** is engaged.
- There are no loose items in the vehicle. Do not place heavy items in overhead storage areas.
- You check your fuel supply. Be sure you have enough to reach your next fuel stop.
- You close exterior sewer caps and close the sewer valves.
- You check for overhead clearance.
- Side-view mirrors are properly aligned and tight. To drive safely, you must use the side view mirrors, so try to become accustomed to them as soon as possible.
- You always use a spotter and extreme care in confined areas. The majority of accidents happen while maneuvering in tight conditions such as a parking lot or service station.
- You remember to buckle up!!! It's the law!

• YOU RELEASE THE PARKING BRAKE.

PREPARING TO START YOUR VEHICLE

Before starting the engine, make sure that all vehicle occupants have buckled their safety belts. Make sure the headlamps and vehicle accessories are off. Make sure the parking brake is set. (page 11)

Make sure the gearshift is in "P" – Park. (page 11)

NOTE: When starting a fuel-injected engine, avoid pressing the accelerator before or during starting. Only use the accelerator when you have difficulty starting the engine.

Turn the key to **ON** without turning the key to **START**.

NOTE: Key positions (OFF, ON, etc.) are not marked. (page 7)

TROUBLESHOOTING - If there is difficulty in turning the key, firmly rotate the steering wheel left and right until the key turns freely. This condition may occur when the front wheels are turned or one of them is against a curb or when the steering wheel is turned when getting in or out of the vehicle. Several instrument panel lights will illuminate briefly.

STARTING THE ENGINE

Turn the key to **START** without pressing the accelerator pedal. Release as soon as the engine starts. The key will return to **ON**.

If the engine does not start within five seconds on the first try, turn the key to **OFF**. After ten seconds try again. If the engine does not start after two attempts, wait ten seconds, then press the accelerator pedal 1/3 to 1/2 of the way to the floor and hold. Turn the key to position. When the engine starts, release the key, then release the accelerator pedal gradually as the engine speeds up. Allow the engine to run at idle for a few seconds before driving.

NOTE: If the temperature is below 10° F, allow up to 15 seconds per try for the engine to start.

A computer system controls the engine's idle revolutions per minute or RPM. When the engine starts, the idle RPM runs faster to warm the engine. If the engine idle speed does not slow down automatically, call Traveler's Assistance. Do not allow vehicle to idle for more than 10 minutes at the higher engine RPM.

Extended idling at high engine speeds can produce very high temperatures in the engine and exhaust system, creating the risk of fire or other damage.

Troubleshooting

PROBLEM:

Engine cranks slowly or not at all

SOLUTION 1:

Use emergency start switch. (see right)

SOLUTION 2:

Clean and/or tighten the battery terminals.

EMERGENCY START

Your motorhome has an emergency start switch for use if the engine compartment battery becomes discharged or in cold weather. The switch temporarily connects the coach battery to the engine compartment battery for extra starting power.

To use the emergency start system:

1. Be sure the vehicle is stopped, shift to "P" (PARK) and apply the parking brake.
2. Press and hold the emergency start switch.
3. Start engine with ignition switch.
4. Release the emergency start switch.

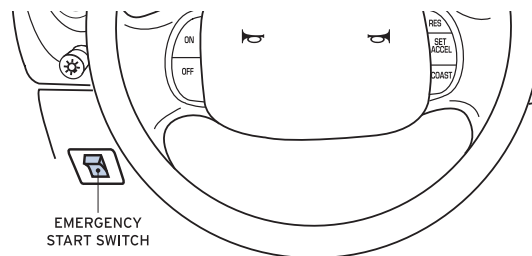

DRIVING YOUR MOTORHOME

Do not park, idle, or drive the motorhome in dry grass or other dry ground cover. The emission system heats up the engine compartment and exhaust system, which can start a fire.

Although odorless and colorless, carbon monoxide is present in exhaust fumes. Take precautions to avoid its dangerous effects. If you smell exhaust fumes inside the motorhome, call Traveler's Assistance immediately. Do not drive if you smell exhaust fumes.

BRAKES

The service brakes are self adjusting. Occasional brake noise is normal and often does not indicate a performance concern with the vehicle's brake system. In normal operation, automatic brake systems may emit occasional or intermittent squeal or groan noises when the brakes are applied. Such noises are usually heard during the first few brake applications in the morning; however they may be heard at any time while braking and can be aggravated by environmental conditions such as cold, heat, moisture, road dust, salt or mud.

IF A "METAL TO METAL," "CONTINUOUS GRINDING," OR "CONTINUOUS SQUEAL" SOUND IS PRESENT WHILE BRAKING, THE BRAKE LININGS MAY BE WORN. CALL TRAVELER'S ASSISTANCE IMMEDIATELY.

FOUR-WHEEL ANTI-LOCK BRAKE SYSTEM (ABS)

Your motorhome is equipped with Anti-lock (ABS) brakes. Use anti-lock brakes like normal brakes. You may feel the brakes vibrate, or you may notice some noise outside your

vehicle, but this is normal. Let anti-lock work for you, but remember: Your front wheels can still stop rolling. If that happens, release enough pressure on the brakes to get the wheels rolling again so you can steer.

The (ABS) symbol on your dash momentarily illuminates when the ignition is turned on and the engine is off. If the light stays on, the (ABS) needs to be serviced. With the (ABS) light on, the anti-lock brake system is disabled and normal braking is still effective unless the brake warning light also remains illuminated with the parking brake released. The ABS performs a self-check after you start the engine and begin to drive away. A brief mechanical noise may be heard during this test. This is normal. If a malfunction is found, the ABS warning light will come on. If the vehicle has continuous vibration or shudder in the steering wheel while braking, please call Traveler's Assistance.

The ABS operates by detecting the onset of wheel lockup during brake applications and compensates for this tendency. The wheels are prevented from locking even when the brakes are firmly applied. In an emergency or when maximum efficiency from the ABS is required, apply continuous force on the brake. The ABS will be activated immediately, thus allowing you to retain full steering control of your vehicle and, providing there is sufficient space, will enable you to avoid obstacles and bring the vehicle to a controlled stop.

The Anti-lock system does not decrease the time necessary to apply the brakes or always reduce stopping distance. Always leave enough room between your vehicle and the vehicle in front of you to stop.

IN CASE OF SUDDEN TIRE FAILURE:

- Avoid heavy brake application
- Gradually decrease speed
- Hold the steering wheel firmly and move slowly to a safe, off-road place
- Park on a firm level spot
- Turn off the ignition
- Turn on the hazard flasher system
- Call **1-800-334-4110** for assistance.

BRAKE-SHIFT INTERLOCK

NOTE: Your vehicle is equipped with a brake-shift interlock feature. This feature prevents you from shifting from **PARK** unless you have the brake pedal depressed. (The ignition must be in the “**ON**” position.)

Always depress the brake pedal before attempting to move the gearshift selector out of **PARK**.

WARNING: When parked, hold the brake pedal down when you move the gearshift selector from one position to another. If you do not hold the brake pedal down, your vehicle may jump while in gear.

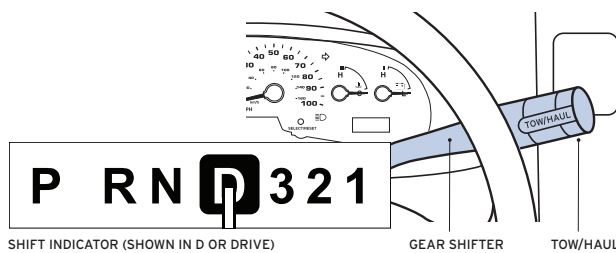
DRIVING USING THE GEARSHIFT**P (PARK)**

Always come to a complete stop before you shift into **P** (PARK). This position locks the transmission and prevents the wheels from turning. To securely latch the gearshift in the **P** (PARK) position, pull it toward you, and push it completely counterclockwise (left) against the stop and then push it toward the instrument panel. The gearshift is securely latched in **P** (PARK) if you cannot rotate it in a clockwise direction without lifting it toward you.

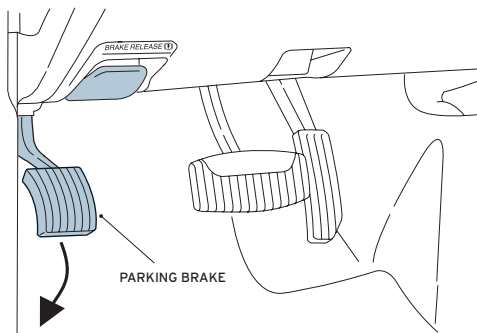

WARNING: When parked, in addition to placing the gearshift in **P** (PARK), you must always set the parking brake fully.

Always turn off the ignition whenever you leave your vehicle. Do not leave your vehicle unattended while the engine is running.

R (REVERSE)

With the gearshift in the **R** (REVERSE) position, the vehicle will move backward. You should always come to a complete stop before shifting into or out of **R** (REVERSE).

N (NEUTRAL)

With the gearshift in the **N** (NEUTRAL) position, the vehicle can be started and is free to roll. Hold the brake pedal down while in this position.

D (DRIVE)

This gearshift position is for normal driving. It allows the transmission to use all gears which reduces fuel consumption and engine wear. As the vehicle picks up speed, the transmission automatically upshifts. If you need more power for passing or going uphill push the accelerator pedal down and the transmission will shift to a lower gear. With the Tow/Haul Indicator Light **ON** (see p. 4), engine braking will occur when descending a grade.

WHEN TO USE 3 (THIRD GEAR)

Use 3 (THIRD) for improved traction on slippery roads and for additional engine braking.

WHEN TO USE 2 (SECOND GEAR)

Use 2 (SECOND) to start-up on slippery roads or to provide additional engine braking on downgrades.

NOTE: Do not go faster than 55 mph (88 km/h) in this gear.

WHEN TO USE 1 (LOW GEAR)

Use 1 (LOW) to drive up or down steep grades and to provide maximum engine braking.

NOTE: Do not drive faster than 30 mph (48 km/h) in first gear.

SAFE DRIVING TIPS

SPEED

- Drive at a steady rate to save fuel. Stay centered in your lane.
- Remember that you are driving a high profile vehicle and be prepared to encounter crosswinds.
- Do not drive when tired. Full concentration is required when driving a motorhome.
- Excessive speed is one of the most common causes of traffic accidents.
- With ideal weather conditions your top speed should never exceed posted speed limits.
- Reduce speed in bad weather to prevent accidents.
- Observe and obey all posted speed limits as they can change suddenly.
- You must pay for all speeding fines and parking tickets at the rental counter upon return.

USE TRUCK LANES AT TOLL BOOTHS

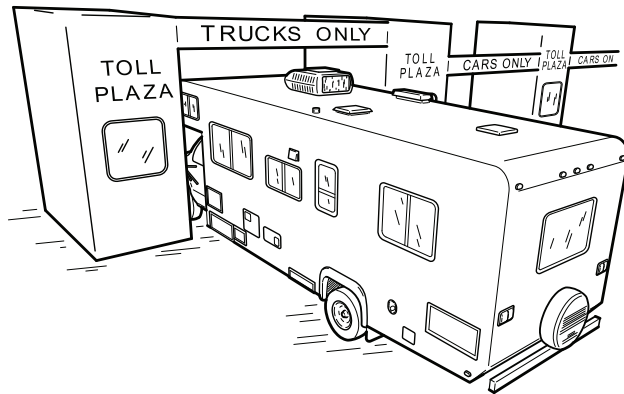

OVERHEAD CLEARANCE

- Always be aware of the dimensions of your motorhome.
- Low hanging tree branches, and canopies and signs at gas stations, restaurants and campgrounds will cause clearance problems.
- Remember that there are items located on the roof (e.g. air conditioner, solar panels and vents) that add substantially to the height of the roof.
- Motorhomes are much taller than a conventional car so it must be kept in mind that at least 12 feet (3.7 meters) clearance is necessary.
- Remember this when approaching gas station canopies, trees, overpasses, tunnels, bridges, toll booths, restaurants, etc.
- Always use truck lanes at tollbooths.

PASSING

Side mirrors do not present a complete rear view when changing lanes. Be careful of your blind spots directly next to the driver and directly behind the motorhome. Due to the motorhome's weight and length, more time and distance is required to pass other vehicles. Make sure there is plenty of clear road ahead.

Remember that your motorhome is much longer than a car, so give other drivers plenty of room before you pull back into the lane.

It is illegal to pass without signaling or to pass on a hill, curve or crosswalk.

NIGHT DRIVING

Don't if possible. A disproportionate number of accidents occur at night. A tired driver, especially one exceeding recommended speed and poor driving conditions can contribute to an accident.

PARKING AND BACKING UP

Do not depend on your mirrors when backing up!!! Always use a spotter -- have someone outside of the motorhome to check for overhead clearance, side clearance and obstacles whenever possible. Allow for adequate mirror clearance.

Wheels should be turned toward the curb, vehicle in P (Park) and the parking brake applied when parked.

BACKUP ALARM

Your motorhome is equipped with a backup alarm. This alarm consists of a loud repetitive "beep" "beep" "beep" to warn people behind you that you are backing up. This tone is automatically generated whenever you put the gearshift lever in the reverse position.

BACKUP RADAR

Your motorhome is equipped with backup radar. This radar beeps inside the cab whenever the vehicle nears an object. The radar beeps slowly when you are within 6 feet of an obstruction. It beeps quickly when you are within 2 feet of the obstruction. When you hear this quick beeping, stop backing up!

HILLS (UP AND DOWN DRIVING) (SEE TOW/HAUL PAGE 4)

When climbing hills, the transmission will automatically shift to lower gears. This decreases the strain on the engine and saves gas. Do not press the gas pedal to the floor on steep grades. This wastes gas, overheats the engine and transmission and can cause permanent damage. Use just enough gas to maintain forward progress.

When descending hills, shift to a lower gear to reduce speed to a slower, safer level. Never use brakes as the sole method to control downhill speeds. Constant brake use can render their stopping power useless. The lower gear level uses the engine to "brake" the vehicle. Never ride your brakes down a hill. That will cause brake overheating and eventually failure, for which you will be responsible.

TURNING

Make turns slowly and with caution.

Remember that motorhomes have a much wider turning radius than a car. Make wide turns and watch for side and overhead clearance. Overhead clearance is not always marked. Watch for the rear of the vehicle to swing out.

BRAKING AND STOPPING

DO NOT TAILGATE! ALLOW AT LEAST FOUR SECONDS BETWEEN YOURSELF AND THE VEHICLE AHEAD ON NORMAL SURFACES. When the vehicle ahead of you passes a certain point, such as a sign, count "one-thousand-one, one-thousand-two, one-thousand-three, one-thousand-four." This takes about four seconds. If you pass the same point before you finish counting, you are following too closely. For slippery surfaces, allow even more space.

Prolonged use of your brakes may result in overheating and possible brake fade requiring greater stopping distances.

Avoid sudden stops. Abrupt braking or speed changes on a slippery surface can cause skidding, loss of control and accidents.

ACCESS CONTROL DEVICES (TIRE SPIKES)

Be aware of access control devices. These devices are made to punch holes in and ruin your tires. There may be signs to warn you of these. You are responsible for all tire damage due to negligence.

INCLEMENT OR FREEZING WEATHER

Reduce speed in windy or wet conditions.

The size of motorhomes make them susceptible to crosswinds.

Braking distances are increased when driving on ice, snow or rain. Allow extra room between you and the vehicle ahead.

In severe weather conditions drive slowly with the headlights on. Avoid soft shoulders after a rain. You are responsible for tow charges if you get stuck.

IF DRIVING IN SNOW, DO NOT USE SNOW CHAINS. IF CHAINS ARE REQUIRED, DO NOT DRIVE! SNOW CHAINS CAN DAMAGE THE MOTORHOME. THE USE OF SNOW CHAINS ON OUR MOTORHOMES IS STRICTLY PROHIBITED.

In the case of a **DUST STORM**, pull off the road and turn your lights off.

In extremely **HOT CLIMATES**, avoid driving in midday. If you must drive, drive slowly. Keep the air conditioning off until you are driving on level roads. Bring extra water.

In case of sub-freezing weather, special operating procedures are required to prevent freeze damage (see "Winter Operations and Freeze Damage" on page 45). This is your responsibility and **YOU WILL BE RESPONSIBLE FOR ANY DAMAGE THAT MAY OCCUR.** Check with your rental station prior to departure or call Traveler's Assistance if freezing conditions should occur. It is the responsibility of the renter to notify a Cruise America representative if they plan to travel into freezing conditions. A Cruise America location will winterize your vehicle for a fee upon request.

Freezing temperatures also have an effect on the propane system. In extremely cold weather, there may not be enough heat outside to vaporize the liquid propane in your propane tank. This can reduce or even stop the flow to your appliances.

If you have any further concerns regarding these conditions please call Traveler's Assistance

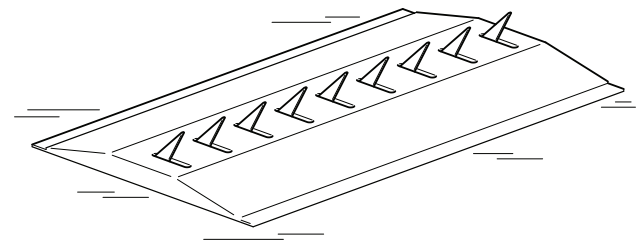

ACCESS CONTROL DEVICE (TIRE SPIKES)

STOPPING FOR FUEL AND PROPANE (L.P. GAS)

Before Refilling the Fuel Tank and/or LPG Tank:

- Turn off all gas appliances and pilot lights (furnace, water heater, refrigerator, and range). Turn off the propane tank.
- Turn engine and generator off.
- Use only regular unleaded gasoline.

WARNING: NO DIESEL. If diesel is added to a gas engine, the customer will be responsible for any and all charges due to having the engine flushed, disposal charges, environmental charges and charges for any repairs and/or towing.

- Check tires and tire air pressure. The recommended pressure is 80psi for "cold" tires, i.e., when the vehicle has been parked for at least one hour or has been driven for less than 3 miles.

⚠ WARNING

**MAINTAIN PROPER
AIR PRESSURE
TIRE: LT225/75R16
PSI COLD: 80
(KPA: 550)**

WARNING: DO NOT UNDERINFLATE THE TIRES FOR A SMOOTHER RIDE.

This is a dangerous misconception. Underinflated tires can cause the tires to overheat very quickly causing the treads to separate which will lead to a blow out.

- Check oil, transmission fluid, engine coolant, and windshield wiper fluid every time you fill up. If oil changes or transmission fluid are required you will be reimbursed. Save the receipts. Use 5W-20 engine oil.
- Check generator oil level (with generator shut off) after every 6 hours of use. Use SAE 30 oil for the generator. (see page 26)
- Check brake lights and turn signal light operation.
- Adjust mirrors.
- Do not remove radiator cap for any reason at any time. Serious injuries could occur. Always check coolant level visually at see-through coolant reservoir. Add coolant if necessary.
- Do not leave valuables in the motorhome when unattended. Always take them with you.
- When you stop for a period of time, check under the motorhome to see if there are any leaks from the vehicle. If there are, investigate.
- Make sure brake fluid levels are between the MIN and MAX lines for normal operating range. If the fluid levels are outside the normal operating range, call Traveler's Assistance to schedule a repair
- Remember that, other than the addition of fuel and lubricants, a professional must perform all maintenance service.
- Always have someone outside the vehicle guide you while you are parking or backing up.

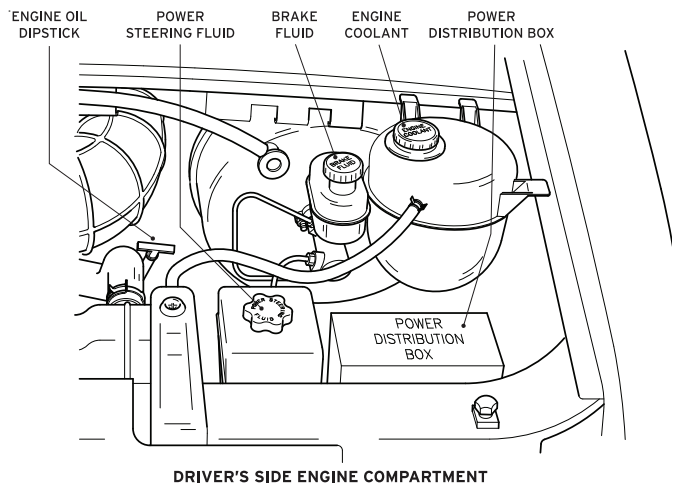
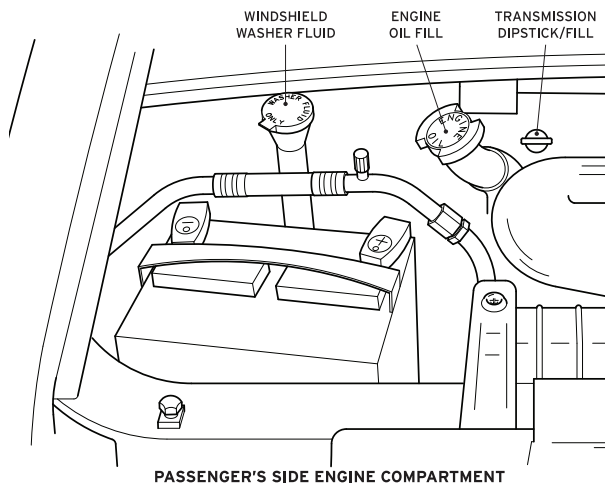

ACCIDENTS, SERVICE & MAINTENANCE

ACCIDENTS

In case of an accident, notify Cruise America immediately by calling toll free **1-800-334-4110** and make a full report in writing upon return. Always get a police report. Sometimes the police are unable to come to where you are. In this case, give them your information by telephone and ask them for a file number. If it is not possible to obtain a police report you are required to get all information from the other party, including full name, vehicle license number and state of registration, insurance information and a written explanation of the details of the accident.

All accidents involving another party **MUST BE REPORTED WITHIN 24 HOURS**. You must provide a police report, file number and complete an incident/accident report upon return of the rental vehicle.

INSURANCE IDENTIFICATION (ID) CARD

When you rented your RV, you were given an insurance identification (ID) card. Please leave this insurance identification card and the vehicle's registration papers inside the motor home. Do not carry these documents with your personal papers.

EMERGENCY SERVICE AND REPAIR

In case of mechanical failure rendering the vehicle inoperable, get the vehicle completely off the road at the first opportunity. Call **1-800-334-4110** for instructions. Never abandon the vehicle under any circumstances.

All repairs over \$75.00 require an authorization from Traveler's Assistance. Repairs and incidentals up to \$75.00 do not have to be phoned in to Traveler's Assistance. Maintaining fluid levels does not require authorization. Keep all receipts for reimbursements.

TIRE REPAIR

In case of a flat tire, a spare tire is provided. For your safety, we do not provide tire-changing tools. Call **1-800-334-4110** for assistance.

HOW TO GUARD AGAINST REPAIR SCAMS

When at a gas or service station never leave your motorhome unattended. Watch closely what the service attendant is doing and ask questions. Beware of high-pressure sales tactics. Call Traveler's Assistance before you agree to any repairs.

Remember: Repairs over \$75.00 require our authorization, or you will not be reimbursed. Repairs and incidentals up to \$75 do not have to be phoned in to Traveler's Assistance.

We recommend making required oil changes at national firms, such as Jiffy Lube, Ford or Goodyear. Most oil changes should cost about \$75.00. Ask for the price of an oil change before the work is done. If it seems too high, call Traveler's Assistance at 1-800-334-4110 or go to another service station.

SAFETY EQUIPMENT

SMOKE DETECTOR ALARM

CAUTION: Please do not disconnect the smoke alarm for the sake of convenience when cooking foods that may set it off. Instead open windows and doors to air the unit out.

Your motorhome comes with a smoke detector alarm for your protection and peace of mind. The alarm is powered by a replaceable 9-volt battery. If it needs to be replaced, it will begin to emit a chirping sound. Replace the battery with a fresh one which you will find in your Departure Kit.

LOCATING THE SMOKE ALARM

The smoke alarm is round in shape and will be attached to the interior ceiling of the motorhome.

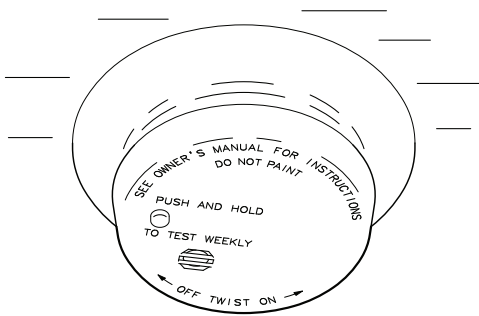

REPLACING THE BATTERY

1. To install the new battery, remove the smoke alarm cover from the mounting bracket by twisting clockwise.
2. Remove and discard the existing battery.
3. Install new battery (supplied in your Departure Kit).
4. Check to make sure that the battery connections are secure and the battery is secured in its compartment
5. Test alarm by depressing test button.
6. Reinstall alarm by aligning tabs on ceiling bracket and turning counterclockwise.
7. Test alarm again.

FIRE EXTINGUISHER

Your motorhome is equipped with a dry chemical fire extinguisher. It is rated for type B fires (liquids and grease) and type C fires (electrical). To use the fire extinguisher, pull the ring at the top, aim the nozzle at the base of the flames and press or squeeze the lever.

Cover the entire width of the base of the flames by sweeping the nozzle from side to side.

LOCATING THE FIRE EXTINGUISHER

The fire extinguisher is located at the side of the step well by the coach entry door.

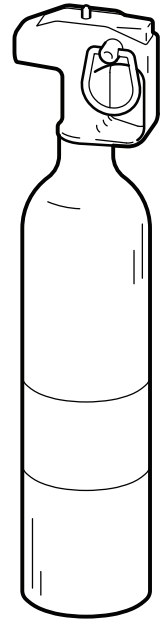

L.P. GAS LEAK DETECTOR

The L.P. detector is an electronic device designed to detect and alert you of a possible L.P. Gas leak in the motorhome. The detector immediately warns the operator with a fast beeping sound and turns the gas off at the propane tank.

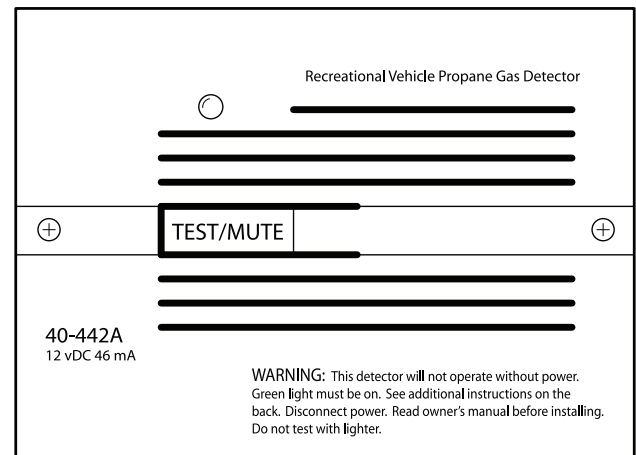

(See page 31 for more information on this detector).

CARBON MONOXIDE DETECTOR

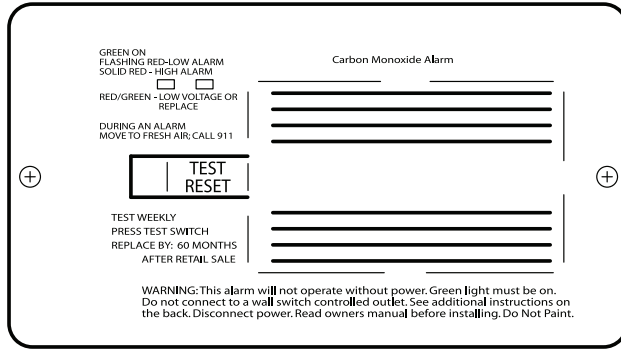

The CO (carbon monoxide) detector is located either above the rear bed or above the dinette. The detector constantly monitors the air inside the motorhome for the presence of carbon monoxide. If dangerous levels of carbon monoxide are present in the interior of the motorhome, the detector will sound an alarm.

When you hear the alarm sound, you must stop the vehicle if you are driving, turn off the motor and the generator, open the door and exit the vehicle. If not driving and you hear the alarm sound, open all windows and the door to ventilate the interior of the motorhome. Make sure nothing is in front of, or blocking the detector. After the coach airs out, reset the detector. If the problem persists, call Traveler's Assistance.

TROUBLESHOOTING THE CO DETECTOR

A chirping sound will indicate a low coach battery. Run the chassis engine to charge the coach battery.

EMERGENCY EXIT

The emergency exit is located at the dining area and/or rear of the motorhome and is marked by the label shown below, located at the window. Open the window and exit the motorhome.



You may also exit the motorhome by the main entry door or the front cab doors.

WINDOW OPERATION

The motorhome windows may be opened by pulling slightly on the latch to release the window and sliding the glass to open. Don't forget to close the windows in case of rain.

When driving or operating the generator, you should keep the windows closed to prevent the entry of exhaust gases into the motorhome.

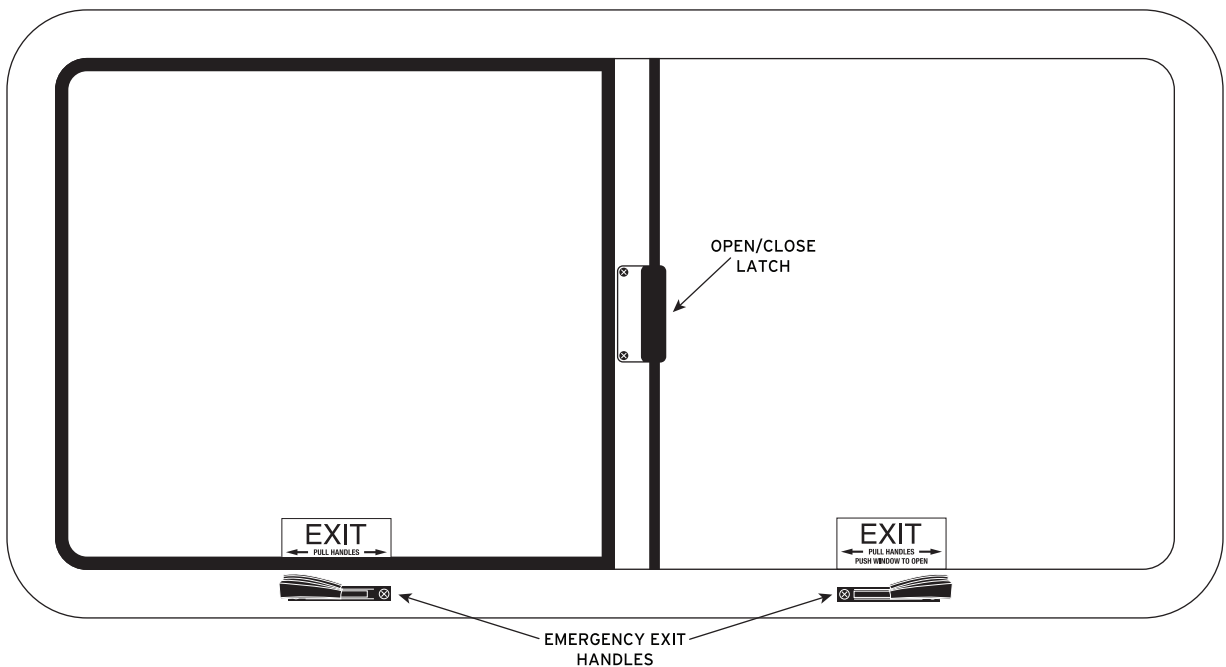
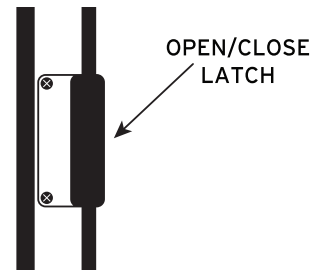

CAMPGROUND TIPS & VEHICLE SPECIFICATIONS

CAMPGROUNDS

ARRIVING AT THE CAMPGROUND

Always try to arrive at your destination while there is still some daylight so you can register and be able to locate your campsite. Some campgrounds have obstructions and trees, which can damage the overhead or undercarriage of the motorhome.

Always ask for a campsite that is level so your refrigerator will work properly.

If you arrive after the campground office is closed, you may still be able to check in after hours. It is helpful to call ahead so the campground doesn't give out your site, also you might end up in a site that does not have full accommodations. While you can still run your generator for electricity, you may be restricted from using your generator after dark.

ELECTRICAL HOOK UP

Ask for electrical hookup whenever possible. If your stay is for longer than one day, you should ask for full hookup (electric, water, and dump facility). This will make your stay more enjoyable, because you will be charging your coach battery, and also running your appliances, without using the 12-volt battery. You will not worry about your appliances not functioning, due to having drained your 12-volt coach battery.

Connecting your motorhome to the campsite electric supply is simple and easy. Just remove the motorhome shore line from the receptacle inside the shore line compartment, and plug into the campsite 120-volt receptacle. You can also use the provided adapter in case the campground only has a 15-amp receptacle.

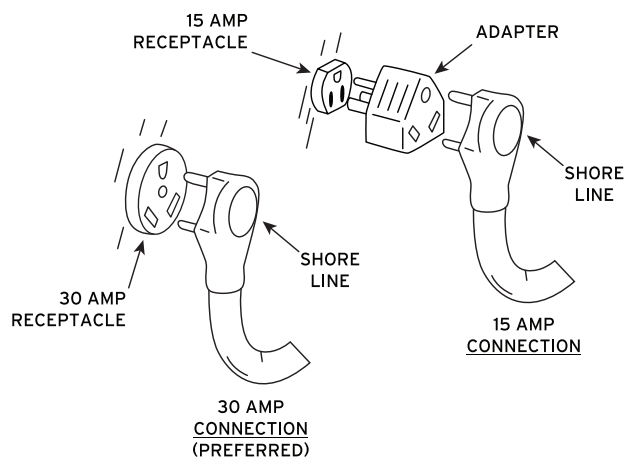

WATER HOOK UP

Remove the fresh water hose and connect to the motorhome and the campsite water faucet. Caution: some campground water supplies are on wells and the water may not be fit to drink. Cruise America strongly recommends bottled water for drinking, ice cubes or any other human consumption.

NOTE: Some campgrounds have very high water pressure, which may cause a leak in your water system. If you encounter very high water pressure we encourage you to use a 30 - 50lb water pressure regulator (available at campground store) to prevent water lines from rupturing.

WARNING: If the overnight temperature is expected to go below freezing for an extended period, you must winterize the motorhome. Please follow the instructions in the fresh water system (winter operation and freeze damage) section of this guide. You will be liable for all freeze damage to the motorhome. (See also page 45)

SEWER HOOK UP

Remove the sewer hose from its storage compartment and connect to the motorhome sewage drain outlet. (See p. 43: "Dumping the Holding Tanks".) Keep the two waste dump valves closed, even while connected to the campground sewer system. Monitor the tank levels, and empty the tanks only when the panel reads 3/4 or above. After dumping, close the valves and fill the toilet 1/4 full. Add toilet chemicals, and flush so waste can dissolve in the water.

CAUTION: If you are camping and are able to leave your sewer hose hooked up, please keep the valves closed. Open the valves only for dumping and then promptly close them again. Dump only after the tanks are 3/4 full so there will be ample pressure. If you simply leave the valves open, solid waste will settle and your waste tank will become clogged!

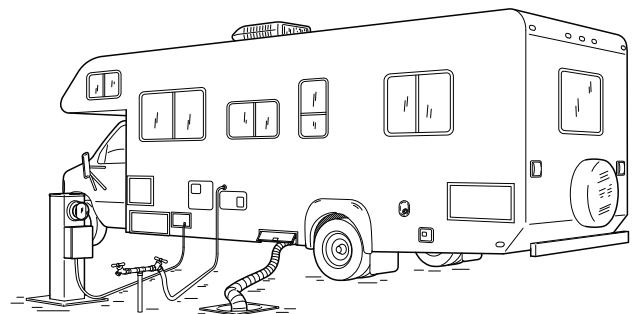

CAMPGROUND ETIQUETTE

Common sense rules of etiquette prevail when you check into any campground, public or commercial. Whether you plan to stay for one night or an extended stay, you are joining a community and you are expected to be a good neighbor and comply with campground rules. You will be expected to not make excessive noise, to respect the environment around you, to clean up any litter and to never run the generator at night.

If you arrive at a campground late in the afternoon or at night, keep your lights dim and make as little noise as possible. It is a good idea to stock up on toilet chemicals and RV toilet paper while you are at the campground since these items will not be available to you at any supermarket.

CAMPGROUND VEHICLE SECURITY

Do not leave valuables in the motorhome while you are away. Take valuables with you. Secure all windows. Close the curtains and the front privacy curtains.

OVERNIGHTING AT PRIMITIVE SITES

If your campsite does not have electrical, water or sewer hookups, ask the campground office where their dump station and water fill are located.

1. If not hooked up to electricity, be sure the engine fuel tank has enough fuel to run the generator. (The generator will use about 1 gallon of fuel per hour of operation and will shut down when the level in your fuel tank drops below 1/4 full.)
2. Be sure that the fresh water tank is full.
3. Light the water heater only when you need hot water. Turn off after use.
4. Use the generator for all electrical operations inside the coach.* **THIS WILL ENSURE THAT YOUR COACH BATTERY REMAINS FULLY CHARGED.** (see p. 23)
IMPORTANT: Using the furnace and your interior lights and appliances will quickly drain your coach battery.
5. Check that the refrigerator pilot light is still lit. If necessary, relight the pilot light per the instructions on the refrigerator section of this guide.

DEPARTING THE CAMPGROUND

1. Disconnect the shore line from the campsite receptacle, plug the end of the electric cord back into the 120-volt receptacle in the motorhome shore line compartment. If you used the 15-amp adapter, store it in the shore line compartment also.
2. Close both dump valves. Disconnect the sewer hose from the motorhome. Lift the hose to drain any liquid from the hose.
3. Turn off the water spigot and disconnect the fresh water hose from the motorhome.
4. If you need to add fresh water to the motorhome fresh water tank, remove the fresh water fill cap and place the hose end in the fill hole. Only turn the faucet partway as the tank has to vent as it fills. Fill the fresh water tank.
5. Stow the sewer hose back in its compartment.
6. Turn off the water and disconnect the fresh water hose from the campground spigot, allowing excess water to drain off before stowing the hose in its compartment.
7. Secure all compartment doors before departing the campsite.
8. Turn off the water heater. We advise this because the water heater is a rapid recovery system.
9. Secure the refrigerator door and check to ensure that your refrigerator is operating on L.P. Gas while you drive.
10. Close roof vents.
11. Make sure all loose articles inside the motorhome are secured and stowed away.
12. Check all tires. If any tires are low, air them up as soon as possible.
13. Adjust side mirrors if necessary.
14. Always have someone outside the vehicle guide you while you are parking or backing up.
15. Latch and deadbolt the entry door.
16. Before driving away, make sure all passengers are buckled up with seat belts.

TYPICAL VEHICLE SPECIFICATIONS

VEHICLE TYPE	Compact	Standard	Large
CLASS	C19	C25	C30
ENGINE	V-8	V-8	V-10
TRANSMISSION	Auto	Auto	Auto
POWER BRAKES	Yes	Yes	Yes
POWER STEERING	Yes	Yes	Yes
DASH AIR CONDITIONING	Yes	Yes	Yes
CRUISE CONTROL	Yes	Yes	Yes
DUAL REAR TIRES	No	Yes	Yes
STEREO SOUND SYSTEM	Yes	Yes	Yes
REFRIGERATOR	Yes	Yes	Yes
FURNACE	Yes	Yes	Yes
COOKTOP BURNERS	2	3	3
MICROWAVE	Yes	Yes	Yes
ROOF AIR CONDITIONER	Yes	Yes	Yes
GENERATOR	US only	US only	Yes
SHOWER	Yes	Yes	Yes
FLUSH TOILET	Yes	Yes	Yes

Capacities (gal./liter)

FUEL (UNLEADED)	40/151	55/208	55/208
WATER HEATER	6/22	6/22	6/22
FRESH WATER	20/76	40/151	40/151
GRAY WATER	18/68	35/132	35/132
SEWAGE (BLACK WATER)	17/64	30/114	30/114
L.P. GAS	12/45	12/45	12/45

Dimensions (ft./meters)

LENGTH (TO NEAREST FOOT)	20'/6.1m	25'/7.6m	30'/9.1m
WIDTH (INCLUDING MIRRORS)	10'/3m	10'/3m	10'/3m
OVERHEAD CLEARANCE	12'/3.7m	12'/3.7m	12'/3.7m
WEIGHT (GVWR - LBS/KG)	9,600/4,354	11,500/5,216	14,050/6,373

NOTICE TO CUSTOMERS: Cruise America and Cruise Canada purchase new vehicles each year from several different manufacturers and we cannot guarantee exact vehicle specifications. The features/amenities are representative and may be added to or deleted without notice. Vehicle dimensions are approximate.

THE MONITOR PANEL

These panels allow you to conveniently check the approximate levels in such items as the fresh water tank, black tank (toilet waste), gray tank (sink & shower waste water) & L.P. gas (propane) tank. You can also check the condition of your aux (coach) battery, turn on the water pump and water heater, and start or stop the generator, if present.

CHECKING TANK LEVELS:

To check the amount of water available in the fresh water tank, push the “levels test” switch and hold. For example, if the tank is 2/3 full, the 1/3 and 2/3 lights will light up on the panel. This will apply to all tank levels on the panel. (See the following table.)

LEVEL	LIGHTS
1/3	1/3
2/3	1/3 and 2/3
FULL	1/3, 2/3 and F

HELPFUL HINTS:

The monitor panel is for convenience and if not working properly won't ruin your vacation. Below are listed alternative ways to check most of your levels.

The L.P. tank has a secondary gauge mounted on the tank. Look there for a tank level.

The fresh water tank will be located either under the rear-facing dinette seat or under the rear bed, depending on which model RV you have. It is translucent white and you can see through it for your tank level.

You can determine the level in black tank (toilet waste) by looking down the toilet to see how full it is. On occasion, the toilet waste tank gauge on your monitor panel may read incorrectly. This is because the sensor probes mounted on the inside of the tank sometimes get coated with particles, causing faulty readings on the panel. To prevent this, always flush with plenty of fresh water when using the toilet. Never pour grease or oil down the toilet. Always use the easily dissolved special RV toilet tissue and clean with dry or liquid enzyme RV toilet chemicals. If you get faulty readings on holding tank one, you may correct this in the following way: First drain the tank. Then fill the tank with water and 1/2 cup dishwashing soap. Then simply drive for a while. The sloshing water will usually clean the probes.

The level in gray tank (sink & shower drain water) cannot easily be determined. However, if you have water coming up in the shower it is an indication that the tank is full.

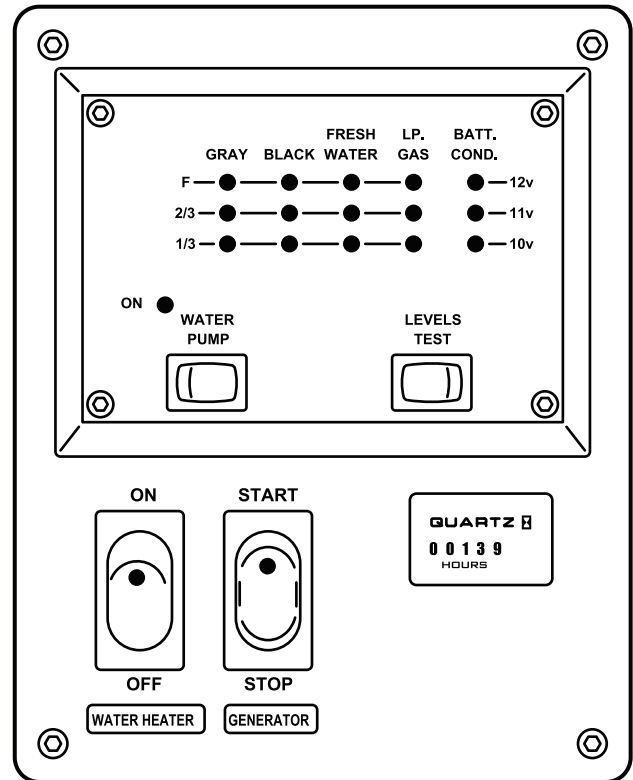

CHECKING BATTERY CONDITION:

The battery condition switch tells you approximately what condition your coach battery charge is in. To check the battery condition, you must first have the shore power disconnected and the generator and engine off. Press the “levels test” switch and the lights on the panel marked 10v, 11v or 12v will light up. If the 12v light is not on, you should charge your coach battery by plugging into shore power or running the engine or the generator.

CONTROL SWITCHES ON THE MONITOR PANEL

On the monitor panel you will find the generator start/stop switch (some models only), the water heater switch and the water pump switch.

The **GENERATOR SWITCH** turns the generator on and off. (see above) For more information, refer to the generator section. (see p. 38)

The **WATER HEATER SWITCH** turns on the water heater for hot water. It also has an indicator light to let you know if it is on or not. Refer to the water heater section for more instructions on water heater usage. (see p. 38)

The **WATER PUMP SWITCH** has an indicator light to let you know if it is on or not.

THE ELECTRICAL SYSTEM

ELECTRICAL SYSTEM

ALL MOTORHOMES ARE EQUIPPED WITH TWO SEPARATE ELECTRICAL SYSTEMS: (1) A 12-VOLT DC SYSTEM (DIRECT CURRENT FROM A BATTERY SOURCE) AND (2) A 120-VOLT AC SYSTEM (ALTERNATING CURRENT FROM A POWER OUTLET OR AN ON-BOARD GENERATOR).

12-VOLT SYSTEM

Your motorhome has two 12-volt batteries: one in the engine-compartment and the other in the coach. The one in the coach is also called the auxiliary battery.

The engine-compartment battery (located under the hood) is charged by the alternator while driving the motorhome. It supplies power to the engine ignition system, dash controls, switches and all exterior lighting of the motorhome.

THE AUXILIARY OR COACH BATTERY OPERATES THE FURNACE, WATER PUMP, L.P. GAS DETECTOR, CO DETECTOR MONITOR PANEL AND ALL INTERIOR LIGHTING. IT ALSO SUPPLIES POWER TO THE ELECTRONIC CONTROLS FOR THE WATER HEATER AND THE REFRIGERATOR.

The auxiliary or coach battery is charged in two ways:

- From the vehicle alternator when the engine is running, approx. 30 minutes (this is the most efficient method).
- From the 12-volt system through the power converter (at a lower charge rate using the shoreline or generator, can take up to 6-8 hours).

Troubleshooting the 12-Volt System

1. The coach battery may be low (this can be checked at the monitor panel). You may charge your coach battery by simply running the chassis engine. If the coach battery won't hold a charge, call Traveler's Assistance to arrange for a replacement coach battery.
2. A fuse may be bad. Replacement fuses may be purchased at auto parts stores, hardware stores and some gas stations.
3. The 40-amp circuit breaker may need to cool down or be reset. This breaker must cool down before it resets. On some models, you must push the reset button. On other models the breaker resets automatically (no reset button). The reset button is often on the back side of the breaker and can be felt but not seen. (see p. 24)
4. If the breaker fails and will not reset, there is an electrical overload or other problem and you must call Traveler's Assistance.
5. A rotten-egg odor in the coach indicates sulfur fumes, which are probably coming from the coach battery because of over-charging or a short. Open all windows on coach and call Traveler's Assistance to arrange for repair.

120-VOLT SYSTEM

BY CONNECTING THE MOTORHOME'S POWER CORD TO A 120- VOLT OUTSIDE POWER SOURCE OR THE ON-BOARD OR GENERATOR, YOU MAY RUN THE ROOF AIR CONDITIONER, MICROWAVE AND THE 120-VOLT ELECTRICAL OUTLETS IN THE MOTORHOME.

The 120-volt outlets in the bathroom and kitchen are protected by a Ground Fault Circuit Interrupter (GFCI) This device is intended to protect you against the hazards of electrical shock when using electrical appliances.

NOTE: If the power is on and there is no current to the outlet, push the RESET button (at the center of the GFCI outlet).

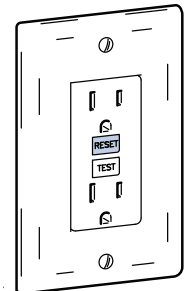

GFCI OUTLET

When using the on-board generator the 120-volt shore line must be plugged into the receptacle located at the shore line storage compartment. (See illustration below)

Troubleshooting the 120-Volt System

1. The shore line must be plugged into either an external 120-volt receptacle or the generator receptacle located in the shore line storage compartment. If using an external 120-volt receptacle, make sure the breaker for that receptacle is turned on. If using the generator receptacle, you must also have the generator running.
2. The circuit breakers in the power converter box must be in the **ON** position. (see p. 25)
3. The 30-amp Breaker on the generator must be in the ON position.(see p. 26)

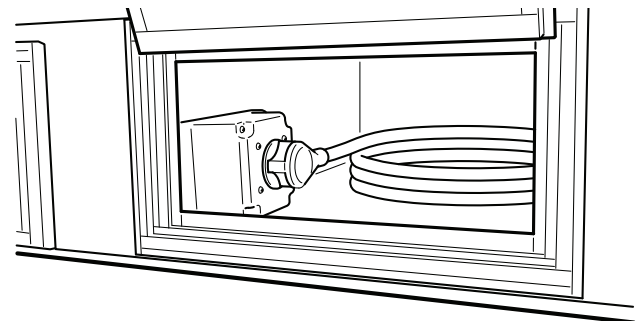

120-VOLT SHORELINE STORAGE/RECEPTACLE

40-AMP Reset Locations

C19:

AT REAR OF COACH

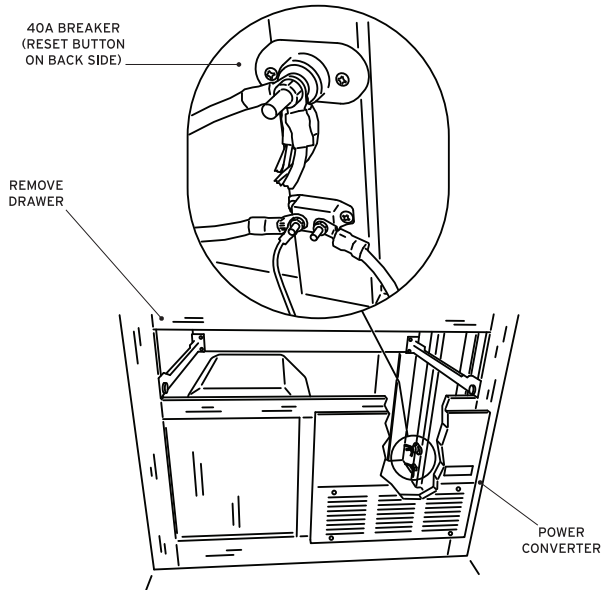

SOME C25'S:

UNDER REAR BED (ALTERNATE LOCATION IS UNDER FORWARD DINETTE SEAT)

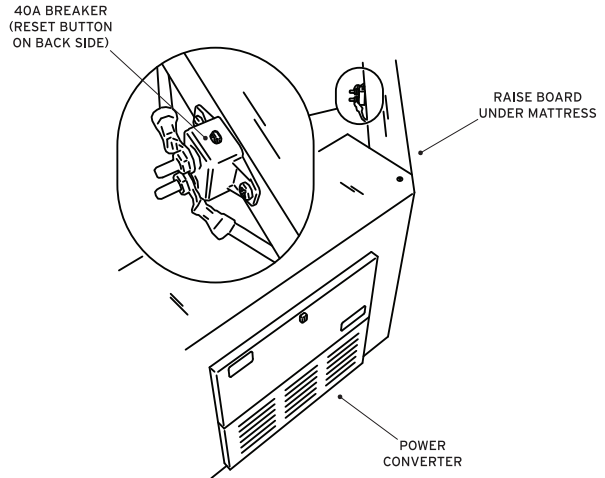

SOME C30'S:

UNDER REAR BED (ALTERNATE LOCATION IS UNDER FORWARD DINETTE SEAT)

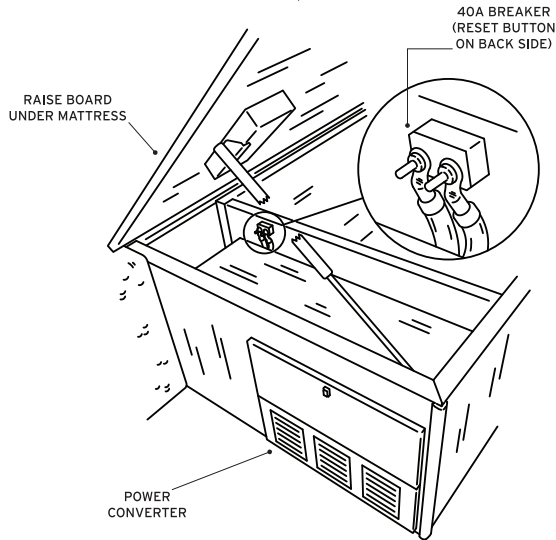

SOME C25'S AND C30'S:

UNDER FORWARD DINETTE SEAT (ALTERNATE LOCATION IS UNDER REAR BED - SEE ABOVE AND LEFT)

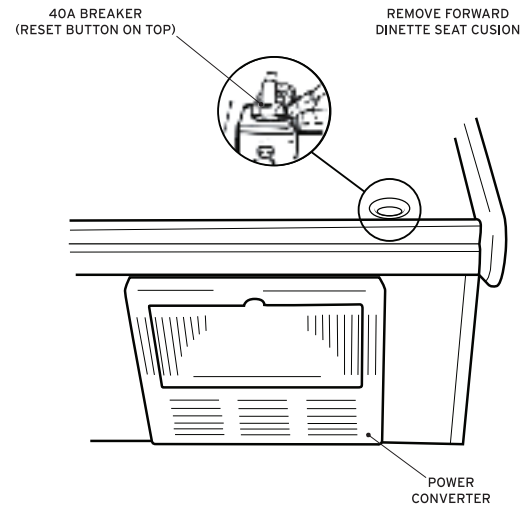

THE POWER CONVERTER

Our vehicles operate on two different electrical systems: a 12-volt DC (direct current) system and 120-volt AC (alternating current) power. A power converter is used to transform 120-volt AC power to 12-volt DC power when the motorhome is plugged into a campground receptacle or plugged into the shoreline receptacle with the generator on. The converter supplies 12-volt DC power to interior lights, fans and water pump. The 120-volt AC provides household current to the wall outlets, roof air-conditioning unit, and microwave.

Converters incorporate a series of automotive fuses and circuit breakers. Warning: If a fuse blows (goes out) it must be replaced with one of the same type and amperage. Replacement with a larger amperage fuse can cause severe damage to the 12-volt DC system.

The 120-volt AC system has a series of circuit breakers. If one of these should trip, move the switch all the way to the **OFF** position until you hear a "click", then press back to the **ON** position as indicated at the breaker. If repeated attempts do not fix the problem, call Traveler's Assistance.

Never store flammable material near the converter. Converters create a great amount of heat and require a lot of ventilation. Keep the area around the converter clear for proper ventilation. If the converter overheats, it will temporarily shut down. The converter has a thermostatically-controlled cooling fan which will cycle on and off. This is to keep the converter cooled when needed.

LOCATION: See page 24 for the location of your power converter.

CHASSIS ELECTRICAL

The chassis or cab has a set of fuses and circuit breakers that are separate from the coach and run independent components on the engine, dash components and exterior lights. It is important that, if you experience a problem with one of these components, you call Traveler's Assistance. There are two fuse boxes: one underneath the dash on the driver's side and the other underneath the hood on the driver's side (usually marked "Power Distribution Box").

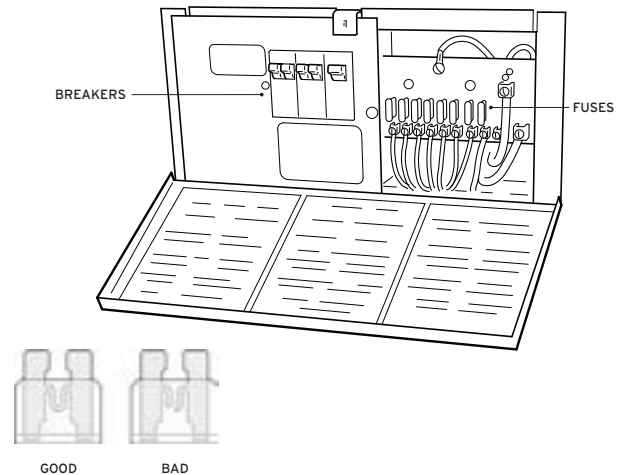

THE GENERATOR

NOTE: Some RV's are not equipped with a generator.

The generator is designed to provide 120-volt electrical power if outside power is not available or when you are traveling in the RV. This feature will allow you to enjoy all the comforts of the RV while traveling or roughing it in the woods. The generator will consume about one gallon of fuel for each hour of operation. The fuel supply is shared with the RV engine and is designed to shut off at 1/4 of the tank's capacity. If you will be camping without the convenience of 120-volt power connection or using the generator while traveling, you will need to plan ahead and refill your fuel tank to allow uninterrupted use of the generator.

NOTE: The 120-volt shore line cord must be plugged into the receptacle in the cord storage area to allow the generator to provide power to any of the RV's systems. (See p. 23).

THE GENERATOR IS DESIGNED TO SUPPLY POWER TO THE FOLLOWING APPLIANCES:

- Roof-mounted air conditioner
- All 120-volt electrical outlets
- Microwave oven
- It will also recharge the auxiliary battery
- Refrigerator (on AC mode)

GENERATOR PRESTART CHECKS:

- Check oil level daily or after every six hours of operation.
- Check fuel level for adequate supply (minimum 1/4 of a tank).

STARTING THE GENERATOR:

- When starting and stopping the generator, you must turn off all electrical appliances, roof a/c and microwave or any outlets currently in use.
- The generator start/stop button is located on the monitor panel by the coach entry door or in the kitchen area. To start the generator, push and hold the "START" end of start/stop button for a period of ten seconds. If the generator does not start, wait for approximately thirty seconds and repeat. See Troubleshooting, p. 27, if the generator does not start.

NOTE: There is a second generator on-off switch on the generator itself. (See illustration below)

STOPPING THE GENERATOR:

- Before stopping, turn off the air conditioner and any other 120-volt appliances in operation. Allow generator to run for two minutes to allow the engine to cool down.
- To stop the generator, press and hold the lower end of the start/stop button until the generator stops completely.

RESTARTING A STALLED GENERATOR:

- Try to determine why it shut down. See Troubleshooting the Generator, (p. 27) and follow the instructions listed.
- **TURN OFF ALL ELECTRICAL APPLIANCES AND RESTART THE GENERATOR.**
- After the generator starts, turn the appliances back on one at a time until you are fully operational again.

RESETTING CIRCUIT BREAKERS:

- If a breaker in the main power distribution panel trips or the breaker on the generator does, you may need to reduce the number of appliances you are attempting to simultaneously operate. To reset breaker in the converter, press breaker to the “off” position until you hear a “click”, then press the breaker back to the “on” position. Try turning off the roof air conditioner when operating the microwave oven. This will reduce the load on the generator. After you are finished with the microwave, turn the roof air conditioner back on.

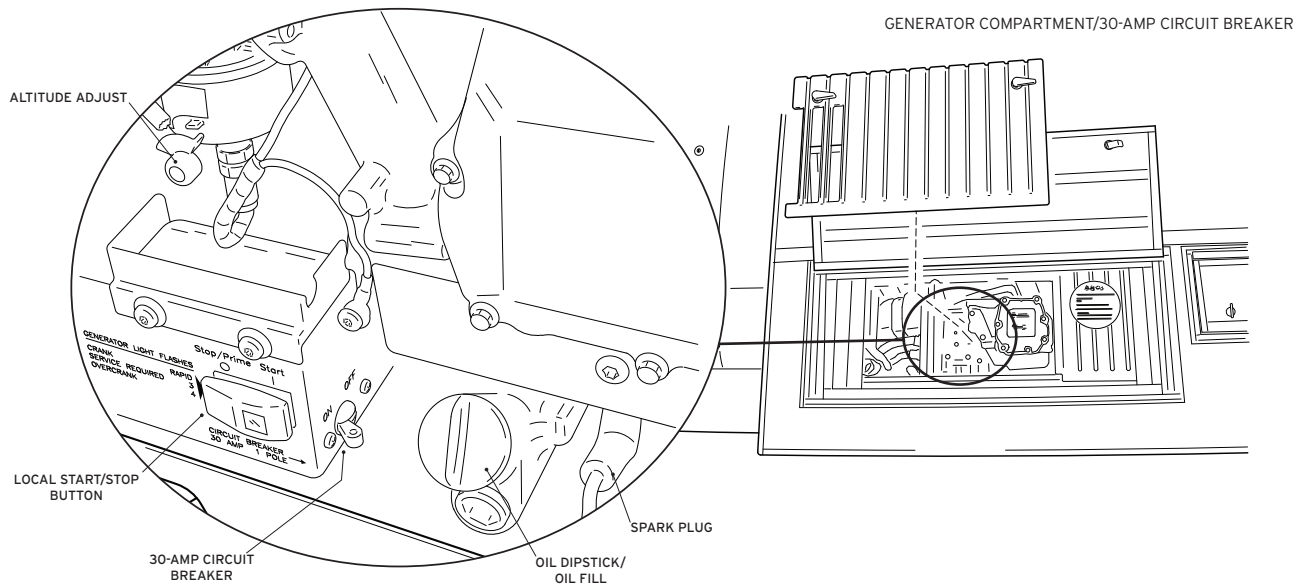
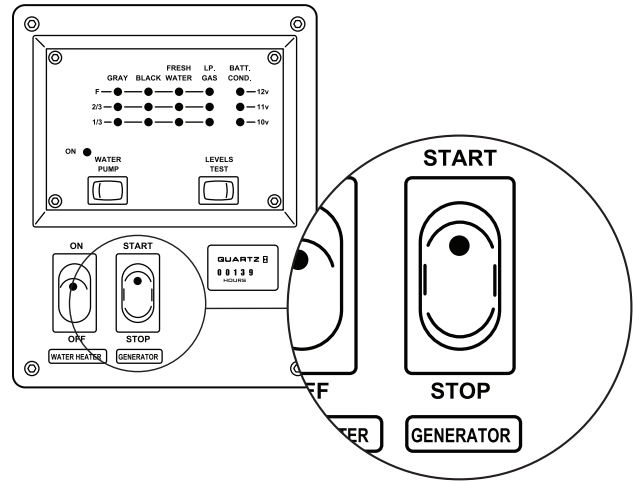

Troubleshooting the Generator

FAILS TO CRANK	1. Low battery	Start chassis engine then start generator
	2. Bad battery connection	Clean and tighten all battery and cable connections
	3. Blown fuse	Replace fuse on control panel
CRANKS SLOWLY	1. Low battery	Start chassis engine then start generator
	2. Bad battery connection	Clean and tighten all battery and cable connections
	3. Load connected	Disconnect load before starting
CRANKS BUT WON'T START	1. Fuel below 1/4 in tank	Add fuel
	2. Low oil level	Add oil if necessary
	3. Plugged fuel filter, bad fuel, fouled spark plug	Call Traveler's Assistance to arrange for service
STOPS WHEN DRIVING AROUND CORNER	1. Low on fuel	Add fuel
	2. Low oil level	Add oil if necessary
	3. Excess oil	Reduce generator oil level
UNIT STARTS AND RUNS, THEN STOPS WHEN START SWITCH IS RELEASED	1. Low fluid levels	Check and bring all fluid levels up to the appropriate level
	2. Possible overheating	Check for blocked air flow and that the generator cover is properly closed
	3. Other functional problem	Contact Traveler's Assistance
CIRCUIT BREAKER TRIPS	Overloaded circuit	Turn off some of the electric load and reset the circuit breaker
GENERATOR RUNS THEN SURGES	Started with load on	Turn off all appliances and restart generator

THE 120-VOLT APPLIANCES

THE MICROWAVE OVEN

ABOUT THE MICROWAVE

The microwaves used in Cruise America motorhomes are manufactured for use in RV's only. Altitude and the type of cookware used can affect cooking times.

NOTE: The microwave operates on 120-volts only. To use 120-volt AC, you must have the shore line plugged into either a campground receptacle or the generator outlet. (The generator outlet is located in the shore line compartment.) If you are plugged into the generator, the generator must be running in order for there to be 120-volt AC.

Like all microwaves, there are certain things that should not be put into it.

NOT RECOMMENDED:

- Glass jars - they may shatter.
- Paper bags - except popcorn bags intended for the microwave - they create a fire hazard.
- Styrofoam plates or cups - they may melt.
- Plastic containers - they may melt.
- Metal utensils and wire ties from bread bags.
- Never use dishes with metallic rims.
- Aluminum foil.

RECOMMENDED USES:

- Glass or ceramic plates and bowls.
- Microwave browning dishes.
- Microwavable plastic wrap, wax paper, paper towel and napkins.
- Paper plates and cups.

Troubleshooting the Microwave Oven

PROBLEM	POSSIBLE CAUSES	CHECKS/SOLUTIONS
Oven inoperative and no display	No 120-volt power to microwave	<ol style="list-style-type: none"> 1. If roof air works, check breakers in converter. 2. If roof air is inoperative, troubleshoot 120-volt system to coach 3. Oven may not be plugged in. (Check in cabinet next to oven).
Display is lit but oven does not heat food.	Oven may be broken	Call Traveler's Assistance to arrange for repair
Sparks or arcing occurs when microwave is turned on	Metal object in microwave	Check for metal or foil objects inside microwave

ROOF AIR CONDITIONER

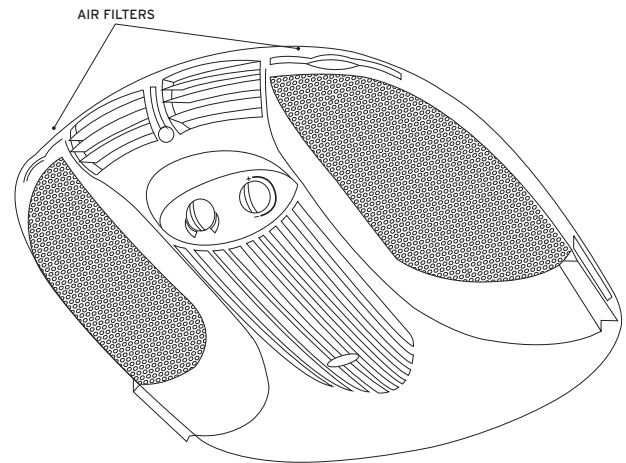
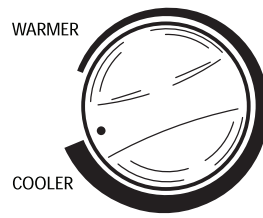
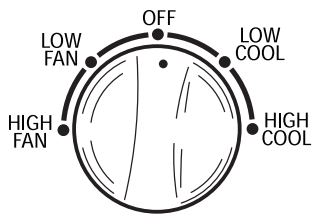

HOW IT OPERATES

Cool air is generated by recycling the air from inside the motorhome (return air), sending it through the evaporator coils and pushing it back into the motorhome (discharge air) through the air grilles.

NOTE: The roof air conditioner operates on 120-volts only. To use 120-volt AC, you must have the shore line plugged into either a campground receptacle or the generator outlet. (The generator outlet is located in the shore line compartment.) If you are plugged into the generator, the generator must be running in order for there to be 120-volt AC.

NOTE: Before turning off the generator (or unplugging the shore line), turn off the roof air conditioner.

The ability of the air conditioner to cool down or maintain a desired temperature depends upon the heat gain of the motorhome, the size of the motorhome, the amount of windows, exposure to the sunlight and the number of people in the motorhome. **AS A RULE, THE AIR WILL BE COOLED 15 TO 20 DEGREES, DEPENDING ON THE OUTSIDE TEMPERATURE AND HUMIDITY.** It is not uncommon to see water dripping from the roof while using the A/C in more humid temperatures. Parking the motorhome in shaded areas, keeping curtains and blinds drawn, and avoiding the use of heat producing appliances will help reduce the heat gain.

When the outdoor temperatures drop in the evening to below 75°F, the temperature control should be set midway between **WARMER** and **COOLER**. Otherwise the evaporator coil may become iced up and stop cooling. Should icing-up occur, it is necessary to turn the air conditioner off for at least 45 minutes to clear the coil of ice. Alternatively, you may turn the selector to the **HI FAN** position until increased airflow is observed.

When the air conditioner is in operation, its compressor circulates refrigerant under high pressure. Once it is turned off it takes 3 to 4 minutes to equalize the pressure. Therefore, once it is turned off it is important to leave it off for 3 to 4 minutes before starting it again. "Short cycling" the compressor will sometimes trip the circuit breaker.

AIR CONDITIONER START UP

1. From the ceiling assembly, turn the selector switch to the **LO COOL** or **HI COOL** position.
2. Rotate the thermostat (temperature control) to the position most comfortable to you.
3. Position the louvers to the desired direction the discharge air is to flow.

Troubleshooting the Roof Air Conditioner

PROBLEM	POSSIBLE CAUSES	CHECKS/SOLUTIONS
A/C doesn't run	No 120-volt power to roof A/C	1. If microwave runs, check the A/C breaker in the converter 2. If the microwave doesn't run, troubleshoot the 120-volt system
Not cooling or low cooling.	Evaporator coils are iced up. Filter is clogged	Run air conditioner on FAN, HIGH for 45 minutes or turn off for 45 minutes. Remove filters and clean (see p. 29)

OPTIONAL CONTROLS

Some vehicles may alternatively have the Dometic thermostat shown below.

BASIC OPERATING INSTRUCTIONS:

TO SET THE THERMOSTAT: Push the "ON/OFF MODE" button once to turn on thermostat. This will display your current settings. To change these settings push and hold the "ON/OFF MODE" button until the "FAN" setting lights up on the left side of the thermostat. Push MODE to cycle between selections. Once thermostat is set to desired function use the "+" and "-" buttons to regulate the temperature.

TO CHANGE FROM FAHRENHEIT TO CELSIUS: Push and hold the + and - buttons. On the right hand side of the screen you will see the F at the bottom or C at the top to indicate what temperature degree setting you are in.

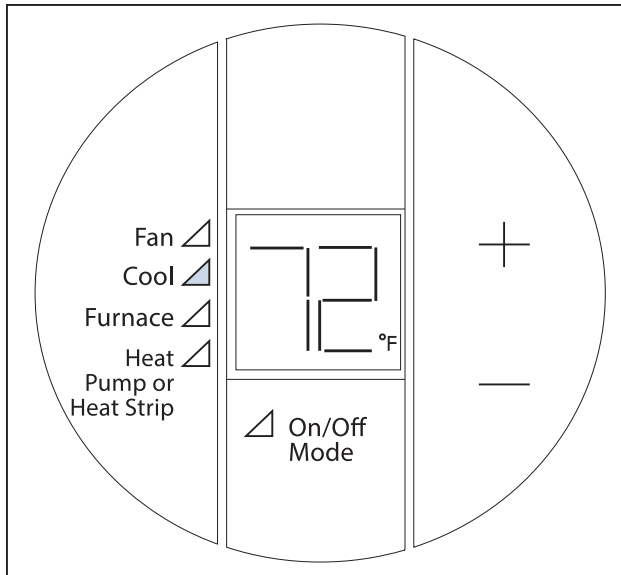

ERROR CODES:

- E1** Loss of communication between the thermostat and furnace/AC board. Please call Traveler's Assistance.
- E2** Thermostat too hot to operate (can happen when outside temperatures near or exceed 100 degrees F). Hold a cold bottle of water or frozen item under thermostat to cool it down. After about 5 min the thermostat should be ready for use again. If still showing error code, please call Traveler's Assistance.
- E3** Shorted indoor temp sensor. Service is needed please call Traveler's Assistance.
- E4** Heat pump operation is locked out. Unit should still function properly. If not, service is needed. Please call Traveler's Assistance.
- E5** Cooling coils in rooftop AC are too cold to operate. Turn off AC unit for approx 45 minutes to 1 hour to let coils thaw. If not working, please call Traveler's Assistance.

THE L.P. GAS APPLIANCES

L.P. GAS SYSTEM

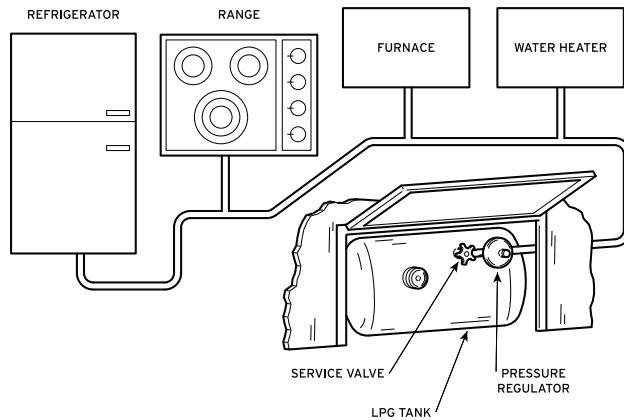

Your motorhome is equipped with a propane gas system designed to provide fuel to the following appliances: refrigerator, range, furnace and water heater.

The propane tank is located outside the motorhome (see illustration). The main shutoff valve, also called the service valve, is located on the tank and will need to be open to operate your gas appliances.

The L.P. system is designed to allow you to operate the motorhome with the propane tank turned on. This allows the refrigerator to cool as you travel.

CAUTION: ALL GAS APPLIANCES (REFRIGERATOR, RANGE, FURNACE AND WATER HEATER) MUST BE TURNED OFF BEFORE YOU BEGIN REFUELING.

Close (twist clockwise) the service valve at the L.P. tank (illustration above) before you begin refueling the motorhome.

IF YOU SMELL GAS:

1. Extinguish any open flames, pilot lights, and all smoking materials.
2. Do not touch electrical switches.
3. Shut off the gas supply at service valve located on the L.P. tank.
4. Open doors and other ventilating openings.
5. Leave the area until odor clears.
6. Have the gas system checked and leakage source corrected before using again.

Cold weather operation: In extremely cold weather, there may not be enough heat outside to vaporize the liquid propane in your propane tank. This can reduce or even stop the flow to your appliances.

For other cold-weather issues, please see pages 13 and 45.

L.P. GAS LEAK DETECTOR

The L.P. detector is an electronic device designed to detect and to alert you of a possible L.P. Gas leak in the motorhome. The detector immediately warns the operator with a fast beeping sound and turns the gas off at the propane tank. It is important to note the detector is sensitive to more than just L.P. Gas. Other combustibles that may be detected include alcohol, colognes, perfumes and most cleaning fluids.

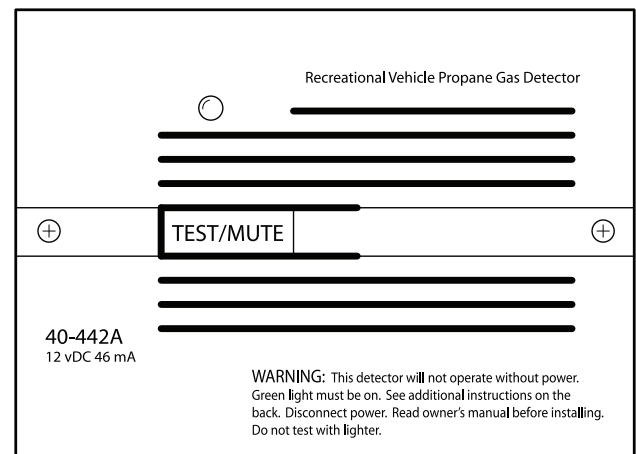

The detector is located near the floor of the motorhome in either the entry step, kitchen or dinette area.

The detector is powered by the coach battery. When the battery voltage falls to below 10.5 volts, the L.P. system will automatically shut off and the detector will begin to chirp at a slow pace. If this happens, you will need to start the generator or the engine to allow the coach battery to recharge.

For startup or restart conditions, light one of the burners and allow it to burn for approximately thirty seconds or until the flame is burning evenly. If the stove will not light see "Troubleshooting the L.P. Gas System" (see p. 32).

Troubleshooting the L. P. Gas System

PROBLEM	POSSIBLE CAUSES	CHECKS/SOLUTIONS
No L.P. to L.P. Gas appliances	<ol style="list-style-type: none"> 1. Valve off at tank 2. Low coach battery 3. Out of L.P. 4. Sub-zero temp. Tank too cold to vaporize L.P. 	<p>Fully open the valve at the L.P. Tank (counterclockwise)</p> <p>Run engine to charge battery</p> <p>Refill L.P. tank</p> <p>Move to a warmer locale</p>
L.P. flowing but appliances won't light	Air in lines	Expel air from lines (see troubleshooting guide for refrigerator (p. 34), furnace (p. 36), or water heater (p. 39))
LPG detector alarm activated (rapid and loud alarm) or will not reset	Combustible fumes in area of detector.	<ol style="list-style-type: none"> 1. Air out coach and try to reset detector. If detector will not reset then turn off main LPG valve at tank and call Traveler's Assistance as soon as possible to arrange for service 2. Make sure nothing is blocking the detector 3. If aerosols have been sprayed, this can activate the alarm
LPG alarm chirping (slowly)	Low coach battery	Run engine to charge coach battery.

THE REFRIGERATOR

Motorhome refrigerators are completely different from the one you have inside your home. A motorhome refrigerator is an absorption refrigerator. Rather than applying direct cold, heat is drawn out from the refrigerator. There are no moving parts, the whole process is based on chemistry and physics, rather than mechanics. While effective, there are limitations inherent in this system.

The average cooling temperature of a recreational vehicle refrigerator is around 60° F (15° C) and it can vary depending on the outside air temperature. Avoid opening the refrigerator for extended periods of time as this will warm the refrigerator and its contents and it can take up to 6 hours to bring the temperature back down to 60° F.

Here are some helpful hints to help keep your perishable food items cold:

1. Pre-cool your food if possible. This gives the unit a break and keeps temperatures down inside the refrigerator.
2. Proper refrigeration requires air circulation within the refrigerator. It is essential that the shelves are not covered with paper or large food items as this will restrict airflow.
3. Please park your RV on level ground. The refrigerator will not work properly if the motorhome is not level.
4. Don't open the refrigerator doors more than necessary.

EACH OPENING WILL INCREASE THE TEMPERATURE BY ABOUT 10°F (6°C). It can take up to 6 hours to bring the temperature back down to a sufficient cooling temperature.

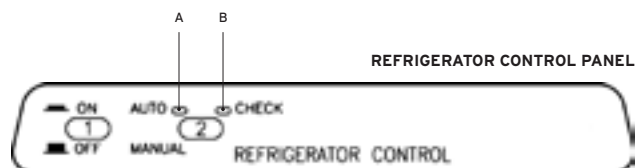
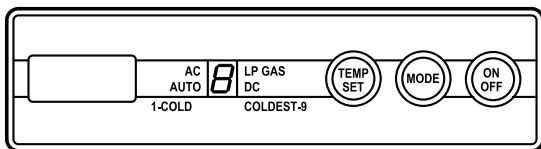

1. ON/OFF BUTTON (MAIN POWER)
2. AUTO/GAS MODE SELECTOR
- A. AUTO MODE INDICATOR LAMP
- B. CHECK INDICATOR LAMP (GAS MODE ONLY)

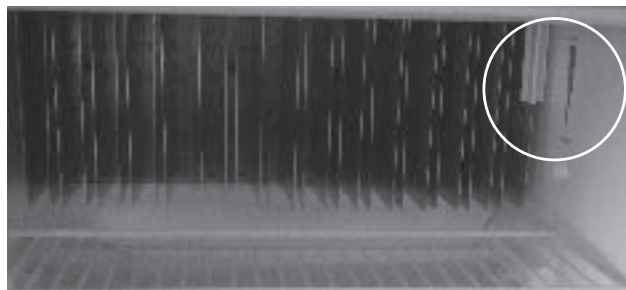

TEMPERATURE CONTROL

OPERATING INSTRUCTIONS

A 12-volt supply must be available for the electronic control of the refrigerator to function. This power is supplied by the coach battery.

START UP

Push ON/OFF button, so button is depressed in the **ON** position.

AUTO

(in the out position) - means refrigerator will automatically switch from L.P. to electric as needed.

GAS

(the button is in the IN position) - means refrigerator will run on L.P. only.

TEMPERATURE CONTROL

Open the refrigerator door. You will see grated panels in the back. On the right side of the panels you will see a slide bar. Slide "up" for cooler, and slide "down" for warmer or use "temp set" on the refrigerator control panel for some models.

SHUT DOWN

Push the ON/OFF button for two seconds.

The refrigerators in some RV's have a resettable thermostat. To reset the thermostat, open the refrigerator access panel on the outside of the RV and depress the red button (see illustration below).

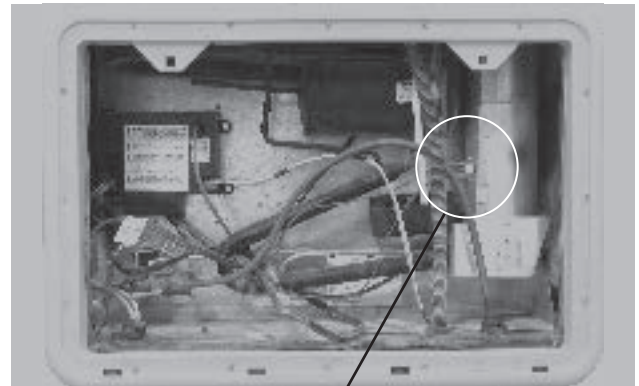

RESETTABLE THERMOSTAT

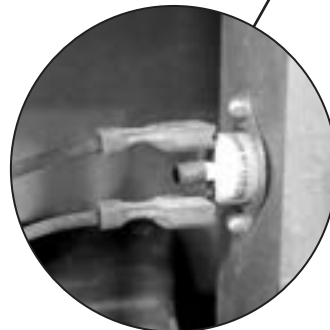

Troubleshooting the Refrigerator - L.P. Gas

If you are experiencing any problems with the refrigerator while using L.P. gas, please check the following items:

1. The **ON** button must be in the **IN** position.
2. The Auto/Manual Button must be in the **OUT** position.
3. The L.P. tank must have L.P. gas and the valve must be open.
4. The L.P. detector must be in the ON position and operational.
5. The 12-volt supply must be operational and charged. (Note: This can be checked at the monitor panel.)
6. The motorhome should be parked on level ground.
7. There may be air in the L.P. line. Cycle the refrigerator on and off several times, wait 30 seconds between cycles.

NOTE: A refrigerator takes up to 6 hours to cool down after starting or with extended periods of being opened and closed.

Troubleshooting the Refrigerator - 120-volt

If you are experiencing any problems with the refrigerator while using 120-volt, please check the following items:

1. The **ON** button must be in the **IN** position.
2. The **AUTO/MANUAL** button must be in the **IN** position.
3. Is the microwave clock on? If so, then the 120-volt system is working and you should check the breaker for the refrigerator in the converter.
4. If the microwave clock is not on, then you should troubleshoot the 120-volt system.
5. The motorhome should be parked on level ground.

NOTE: The refrigerator may take up to 6 hours to cool down after starting or after frequent opening and closing.

STOVETOP (RANGE)

WARNING: IT IS NOT SAFE TO USE COOKING APPLIANCES FOR COMFORT HEATING

HOW IT OPERATES:

The stovetop burners are operated on L.P. gas. The basic operation is the same as a gas stove in a house, but unlike a home, the amount of oxygen is limited in a motorhome due to the size and construction. Therefore, always have sufficient ventilation when using the stove. There is an exhaust fan located in the hood above the stovetop that may be used during cooking for extra ventilation.

USING THE STOVE TOP:

Your RV's stovetop has an Igniter Knob (illustration below). You should light the stove with the Igniter Knob rather than with a match.

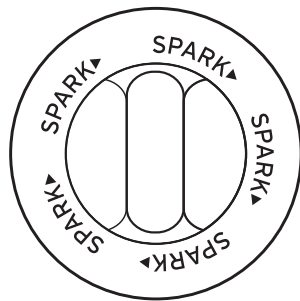

IGNITER KNOB

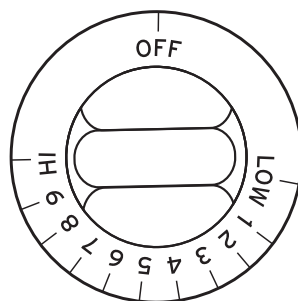

BURNER KNOB

USING THE IGNITER KNOB

1. Turn the valve at the L.P. tank counterclockwise to its fully opened position. (The L.P. detector must be in the ON position and the green light blinking.)
2. Push in and turn the desired burner knob to the desired position.
3. Turn the igniter knob in the direction of the arrows. This causes a spark which will ignite the flame. If the stove will not light, turn the burner knob to the OFF position to stop the gas. You may then try using a match.
4. Adjust the flame to the desired level.

USING A MATCH

DANGER: Misuse of the gas stovetop can result in fire and explosion in an RV just as it can in any kitchen. Use extreme caution when lighting the stovetop burners with a match. To prevent too much unburned propane from accumulating, first light the match, hold it next to the burner and THEN open the burner valve.

THE FURNACE

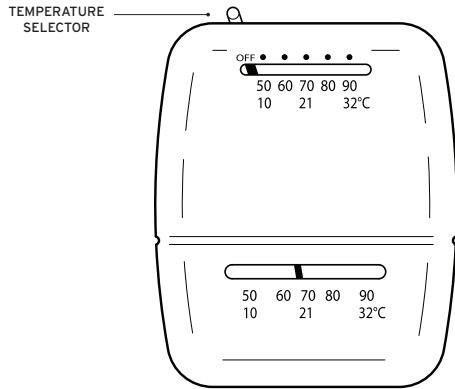

HOW IT OPERATES

Use the wall thermostat to turn the furnace on. Air is heated by burning propane. A blower using 12-volt power from the auxiliary battery circulates the hot air through the motorhome.

WARNING: If the auxiliary battery is not being charged

via the chassis engine, a campground connection or the generator, the furnace blower will discharge it in two to three hours and then the furnace will shut off. If this happens, you may recharge the battery by running the chassis engine for about 45 minutes.

FURNACE START UP

(There are 2 different styles of thermostats in our units - see p. 37)

1. Verify the propane is turned on in the full open position and the L.P. detector is in the ON position and the green light is flashing.
2. Move temperature selector on the wall thermostat to its highest position.
3. Allow three to four minutes after the blower motor starts for the air to heat up. The ducts are located near the floor throughout the motorhome.
4. Adjust thermostat to desired temperature setting.

Troubleshooting the Furnace

PROBLEM	POSSIBLE CAUSES	CHECKS/SOLUTIONS
Furnace blows no air	1. Blown fuse	Replace 15-amp fuse at converter
	2. Thermostat operation malfunction procedures	Review furnace start-up
Furnace blows cold air only after a 3 to 4 minute delay time	1. Out of L.P.	Refill L.P. tank
	2. L.P. detector is not on	Turn L.P. detector to on position
	3. L.P. is not turned on	Open the L.P. valve
	4. Air in L.P. lines	Cycle furnace on and off several times, waiting 45 seconds between cycles
Heats only when using external power source	Low coach battery	Check battery condition and charge if necessary

OPTIONAL CONTROLS

Some vehicles may alternatively have the Dometic thermostat shown below.

BASIC OPERATING INSTRUCTIONS:

TO SET THE THERMOSTAT: Push the "ON/OFF MODE" button once to turn on thermostat. This will display your current settings. To change these settings push and hold the "ON/OFF MODE" button until the "FAN" setting lights up on the left side of the thermostat. Push MODE to cycle between selections. Once thermostat is set to desired function use the "+" and "-" buttons to regulate the temperature.

TO CHANGE FROM FAHRENHEIT TO CELSIUS: Push and hold the + and - buttons. On the right hand side of the screen you will see the F at the bottom or C at the top to indicate what temperature degree setting you are in.

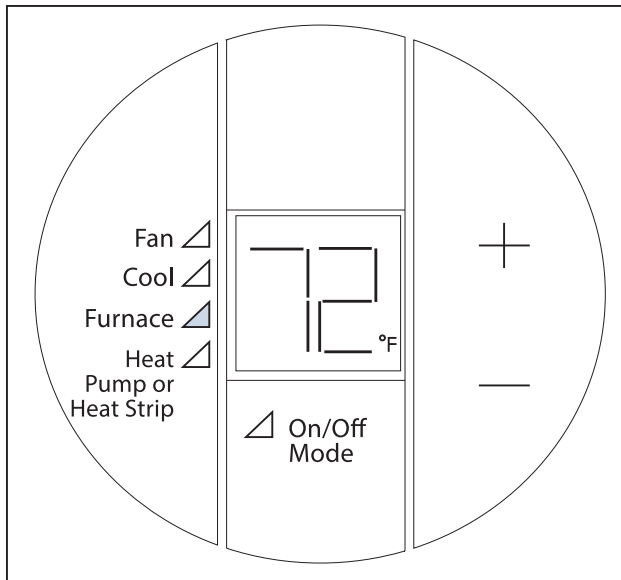

Troubleshooting - Digital Thermostat

Furnace is on but cold air is also coming out of the Rooftop AC unit :

Ensure that the thermostat is set properly. To do this push and hold the "On/Off Mode" button until the "Fan" setting on the left is lit up. Then push the mode button to choose the "Auto" setting under the fan options. Once done, set to "Furnace". Then push the "On/Off Mode" button again and turn on the furnace. If still not working, please call Traveler's Assistance.

ERROR CODES:

- E1** Loss of communication between the thermostat and furnace/AC board. Please call Traveler's Assistance.
- E2** Thermostat too hot to operate. (Can happen when outside temperatures near or exceed 100° F) - Hold a cold bottle of water or frozen item under thermostat to cool it down. After about 5 min the thermostat should be ready for use again. If still showing error code, please call Traveler's Assistance.
- E3** Shorted indoor temp sensor. Service is needed, please call Traveler's Assistance.
- E4** Heat pump operation is locked out. Unit should still function properly. If not, service is needed, please call Traveler's Assistance.
- E5** Cooling coils in rooftop AC are too cold to operate. Turn off AC unit for approx 45 minutes to 1 hour to let coils thaw. If not working, please call Traveler's Assistance.

WATER HEATER

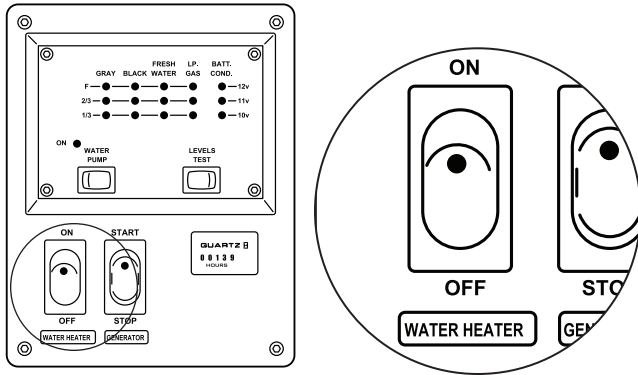

Your motorhome is equipped with an L.P. Gas water heater. The water heater ON / OFF switch is located on the monitor panel next to the generator start button (see illustration above).

1. The water heater has a capacity of approximately 6 gallons of water. The water is supplied from two different sources: (1) campground water supply via a fresh water spigot through a water hose connected to the fresh water hose connection of your motorhome, or (2) a supply of fresh water carried on-board in your fresh water tank. To obtain fresh water from your on-board tank you must turn on your water pump by turning on the WATER PUMP switch located on your monitor panel.
2. The water is heated by burning L.P. Gas. This gas is supplied from your propane tank located on the lower exterior of your motorhome. Note: If you are running low on L.P. Gas, the water heater will not operate.
3. Additionally, the water heater will not operate if there is not sufficient electrical voltage in the 12-volt system to produce a spark to light and maintain the water heater pilot light.
4. Electronic ignition provides convenience and safety. The water heater is turned on or off with the control switch on the monitor panel.
5. The water heater pilot indicator light should come on briefly (up to five seconds) when the control switch is flipped on. If the light does not come on or stays on too long, see the troubleshooting chart below.
6. Water should be sufficiently hot for bathing in about 20 minutes.

WATER HEATER/BYPASS VALVE (UNDER STOVE)

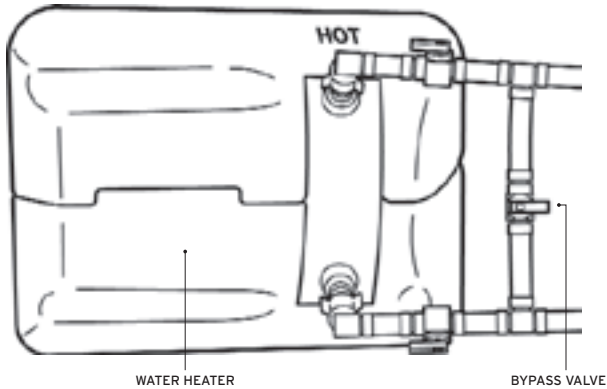

BEHIND WATER HEATER COVER

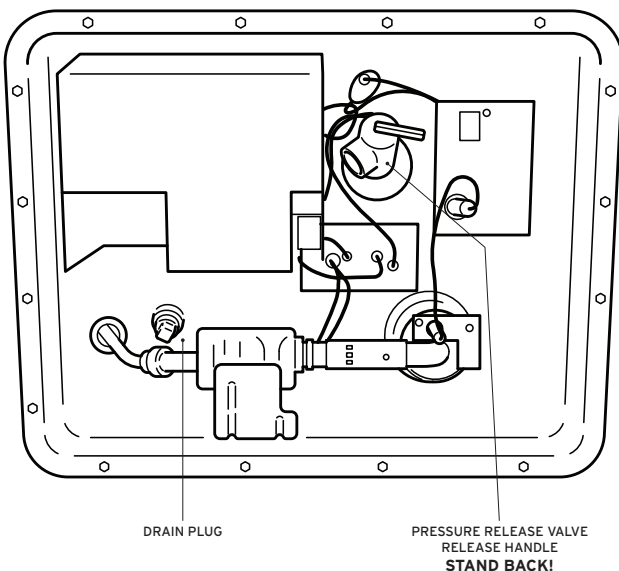

WATER HEATER COVER

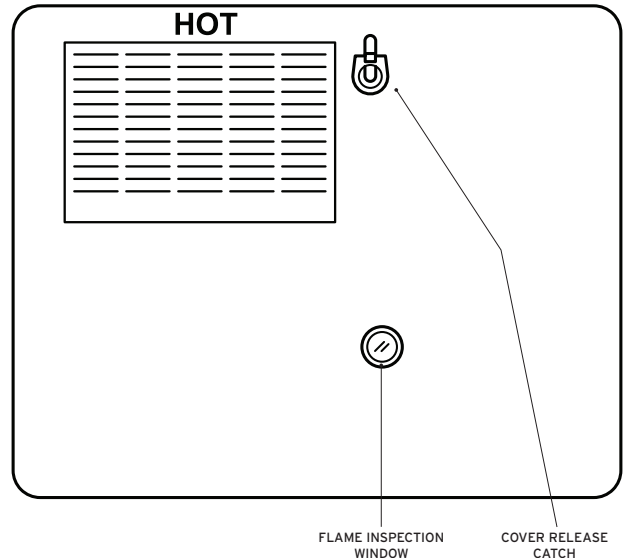

Troubleshooting the Water Heater

PROBLEM	POSSIBLE CAUSES	CHECKS/SOLUTIONS
Red light stays ON	1. You are out of L.P. Gas.	Have the propane tank refilled
	2. L.P. Gas valve is shut off	Turn on L.P. Gas valve
	3. Air in the L.P. Gas line	Cycle water heater several times, wait 30 seconds between cycles
	4. Flame was blown out by wind.	Reposition vehicle away from wind
	5. Low coach battery	See 12-volt electrical section
Red light does not come on at all	1. Water in tank is already hot (water heater will not light until temperature of water drops sufficiently)	Carefully check if water is already hot at faucet
	2. Check fuse at power converter	Replace fuse if necessary
Water heater leaks at relief valve	1. Common due to expansion from heating water to temperature	Briefly open any faucet and this should relieve the pressure
	2. Debris in relief valve	Quickly open and close pressure relief valve behind cover on outside of coach (see opposite page)

CAUTION: WATER WILL BE VERY HOT!

THE WATER SYSTEM

THE FRESH WATER SYSTEM

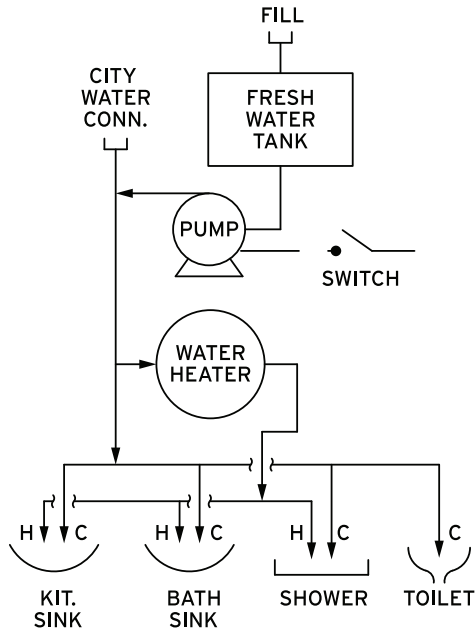

Please note this water is not potable (i.e., not for drinking) so use only for bathing, washing and toilet flushing. You should purchase bottled water for drinking.

You may set your fresh water system for either a city water connection or your on-board fresh water supply (see graphic above).

CAMPSITE WATER HOOK-UP (CITY WATER)

With a campsite water hookup, you will have an unlimited supply of fresh water for bathing, washing and toilet flushing. You should keep in mind, however, that all the water that you use goes into your wastewater holding tanks. Because of this, you will need to check the monitor panel for water and waste water levels occasionally.

To use a campsite water hookup, connect one end of your fresh water hose (located in an exterior compartment) to the campsite water faucet and the other end to your RV's city water connection and then open the campsite faucet 1/4 turn.

If the campsite water pressure is too high, you will need to install an in-line water pressure regulator (available at the campground store for a small fee).

ON-BOARD FRESH WATER SYSTEM (TANK AND PUMP)

Your on-board fresh water system consists of a water pump and a fresh water tank. To fill the water tank, open the cap on the fresh water tank fill and slowly fill the tank until full. The cap may be behind a door on the coach exterior and is labeled "Water Tank Fill" or "Potable Water". Be careful not to have too much pressure, as the tank must be vented when filling.

THE WATER PUMP

First, make sure that there is water in your fresh water tank. Then turn on the water pump with the switch located on the monitor panel. The pump will pressurize the system and make the water flow. The pump runs on 12-volt electricity from the coach battery. The pump is an "on demand" type: as soon as the system is pressurized, the pump will shut off. However, when you are through using water, you should turn the pump switch off.

CAUTION: Do not allow the pump to run when the water tank is empty. Continuous operation with a dry tank could damage the pump.

With the on-board fresh water system you will have a supply of water limited by the amount of water in the fresh water tank. Sizes vary depending on the size of your motorhome.

You are responsible for all damage caused to the vehicle due to freezing of the water lines, toilet, water heater and waste tanks.

Troubleshooting the Fresh Water System

PROBLEM	POSSIBLE CAUSES	CHECKS/SOLUTIONS
Fresh water tank will not take water	1. Water pressure too high	Turn water pressure down
	2. Tank already full	Check monitor panel and run water
	3. Using the City Water connection	Use Fresh Water Fill (has cap, no hose conn.)
Pump fails to start	1. Blown fuse	Check fuse in converter
	2. Low voltage	Connect shore power line to 120-volt to charge coach battery
	3. Faulty pump	Call Traveler's Assistance
City water connection leaks	1. Loose connection	Tighten Connection
	2. Worn or missing gasket	Install new rubber gasket for hose
	3. Leaky hose	Install new hose
No water at sinks, shower or toilet	1. Water pump is off	Turn on water pump
	2. Unit is out of water	Fill fresh water tank
	3. Not hooked up to campsite	Hook up to campsite water source
	4. Campsite faucet not turned on	Turn on campsite water faucet
	5. Coach battery dead	Run the engine to charge the coach battery
Low water flow at sink	Clogged aerator at sink	Unscrew aerator and flush out or leave off
No water at shower	Knob at shower head is turned off	Turn knob on the back of the shower head

THE WASTE WATER SYSTEM

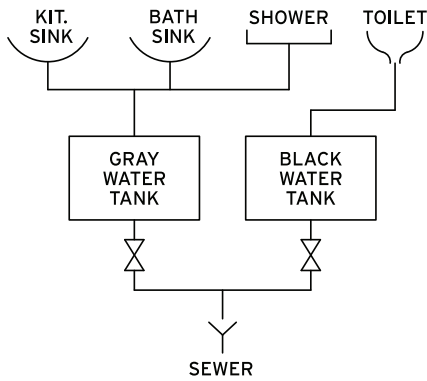

All RV's have 2 wastewater holding tanks: a gray water tank and a black water tank.

The gray water holding tank collects the wastewater from the kitchen, bathroom sink and shower.

The black water holding tank is mounted under the motorhome, directly beneath the toilet, and collects all wastewater from the toilet.

Please observe your monitor panel for the level of your tanks. Your monitor panel will indicate when these tanks are getting full. You will have to manually empty the waste tanks by connecting the sewage hose supplied with your motorhome.

(SEE 'DUMPING THE HOLDING TANKS', THIS SECTION)

THE MOTORHOME TOILET

The motorhome toilet is a fresh water system. To use it, you must turn on the water pump or connect to a campground water supply. Before using the toilet, fill the bowl at least 1/2 full with water. To fill, press the pedal half way down (see illustration).

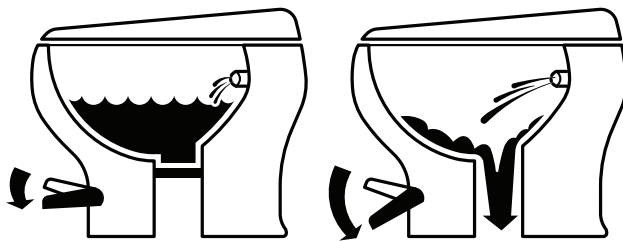

To flush the toilet, press the pedal all the way down. Make sure all waste and tissue have cleared the bowl before releasing the pedal.

CAUTION: Never flush paper towels, facial tissue, feminine napkins or tampons into toilet, as these items will clog the tank drain. If a backup occurs, fill the bowl with hot water and allow to stand. The blockage should dissolve shortly.

NEVER attempt to unclog the RV toilet with caustic chemicals. They will damage the toilet mechanism.

You are responsible for all damage caused to vehicle due to freezing of the water lines, toilet, water heater and waste tanks.

THE HOLDING TANKS (WASTE TANKS)

NOTE: You must empty your waste tanks before you return or pay a cleaning and dumping charge when you return the motorhome. Consult www.rvdumps.com for dumping stations along your route.

DUMPING THE HOLDING TANKS

1. Remove the sewer hose from the exterior storage compartment.

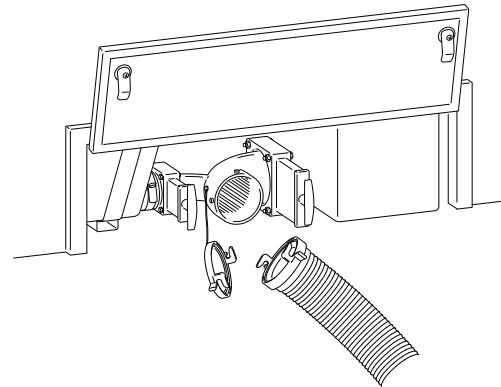

2. Remove the dust cap from the dump valves drain outlet and connect the sewer hose. Make sure the hose is firmly attached.

3. Place the plain end of the sewer hose at least 6 inches into the dump station disposal opening.

4. Open the larger (black tank) dump valve first by pulling the valve handle straight out. This will release the sewage from the black water tank. Wait until the fluid has completely drained.

5. Now pull the smaller of the two valve handles to release the liquid from the gray water tank. The gray water will help flush out the sewer hose.

6. Close the dump valves and remove the dump hose.

7. Rinse the sewer hose thoroughly with water and stow the hose back in the exterior storage compartment.
8. While depressing the toilet pedal all the way down to open the flush valve, add RV waste tank chemical through the open hole directly into the black holding tank. You may use either a chemical packet supplied with your departure kit or additional chemical purchased in the outdoor section of any camping store, supermarket or the like. This chemical reduces odor by breaking up the waste. If you use purchased chemical, please use the appropriate amount for your tank size.
9. Add several gallons of fresh water to the black tank by holding the flush pedal all the way down for about one minute. This water will help prevent waste from clogging the black water dump valve.

REMEMBER: NEVER DRIVE THE MOTORHOME WITH THE WASTE DRAIN OPEN OR WITH THE CAP OFF. (SEE P. 57, RETURNING THE MOTORHOME)

CAUTION: If you are camping and are able to leave your sewer hose hooked up, please keep the valves closed. Open the valves only for dumping and then promptly close them again. Only dump after the tanks are 3/4 full so there will be ample pressure. If you simply leave the valves open, solid waste will settle and your waste tank will become clogged!

Troubleshooting the Wastewater System

PROBLEM	POSSIBLE CAUSES	CHECKS/SOLUTIONS
Water backs up into shower and/or shower will not drain	1. Gray waste tank is full	Dump waste tanks.
	2. Shower drain basket plugged	Clean shower drain basket of hair and debris
Holding tanks will not dump when the valve handle is pulled	1. Tank contents frozen	Try to dump again after you have moved to a warmer climate (above 40°F)
	2. Dump valve broken	Call Traveler's Assistance
Monitor panel says tank full after they have been dumped	Non-RV toilet paper used and now hung up on sensors	Do not run water into tank for a while to let the sensors dry out, then try again. If still not reading properly, try to flush out the tanks several times at dump station

WINTER OPERATIONS

FREEZE DAMAGE PRECAUTION

A motorhome can be used during the colder winter months, however, there is always the possibility of freeze damage to the water system. To prevent this from occurring, there are two types of winterization Cruise America supports.

DRY METHOD

This method must be performed by an authorized RV center and consists of completely removing ALL water from the motorhome, which results in the loss of use of the water system. More commonly used when the motorhome will be stored for 24 hours or more in below freezing temperatures. THIS METHOD IS THE ONLY GUARANTEE AGAINST FREEZE DAMAGE.

WET METHOD

In order to MINIMIZE the risk of freeze damage, if you choose to use the water system in below freezing temperatures, follow the below guidelines.

1. Purchase 4 gallons of RV approved, non-toxic, anti-freeze.
2. Pour 2 gallons of RV non-toxic anti-freeze into the fresh water tank and fill with water to 1/2 full (if tank is full, drain to 1/2 tank).
3. Turn on pump switch and open the cold-water sides of all faucet fixtures. Leave open until the anti-freeze comes out (pink in color). Repeat for hot water side.
4. Flush toilet until anti-freeze begins to flow into the bowl and then pour one gallon of anti-freeze down the toilet to winterize the black tank.
5. Pour anti-freeze down each shower/tub, lavatory sink, and kitchen sink to fill p-traps.
6. To winterize the gray water tank, pour 1/2 gallon down each related sink drain.

NOTE: IF ANTI-FREEZE IS ADDED TO THE SYSTEM, THE SHOWER AND SINK CANNOT BE USED AGAIN UNTIL PROPERLY WINTERIZED BY A PROFESSIONAL RV CENTER.

TIPS FOR COLD WEATHER CAMPING

The water heater and furnace should be on at all times. A minimum of 15-amp power (external shore line) connection is required to operate the RV furnace for extended periods, plus a sufficient supply of propane.

Do not let the motorhome sit for more than 12 hours. Idle the engine or drive the motorhome a short distance at least every 12 hours until normal operating temperature is reached.

In freezing conditions, the propane gas can vaporize and cause the L.P. system to freeze. Following the above steps will help minimize this possibility.

NOTE: SNOW CHAINS ARE NOT PERMITTED UNDER ANY CIRCUMSTANCES.

WARNING: The renter assumes ALL responsibility for ANY damages due to freezing temperatures.

If you have any concerns regarding these conditions, or require assistance with winterizing your motorhome, please call Traveler's Assistance at 1-800-334-4110.

TROUBLESHOOTING INDEX

PROBLEM	SUB-PROBLEM	CAUSES	SOLUTIONS
120-volt Power (p. 23–25)	Generator running but no 120-volt power	Generator breaker is Tripped	Reset breaker on generator
		Shoreline not plugged in inside shoreline compartment	Plug shore line to receptacle inside shore line compartment
		Breakers in converter tripped	Reset breakers in converter
	Plugged into shore power but no 120-volt power in coach	Breaker at shore power hook-up is off	Turn on shore box power
Breakers in converter are off		Reset breakers at converter	
120-volt Power at Receptacles (p. 23–25)	Microwave and A/C/ work but no power to outlets	GFCI tripped	Reset GFCI on bathroom or kitchen 120-volt outlet
		Converter breakers tripped	Reset breakers inside converter
12-volt Power System (p. 23)	No power to amenities	Low coach battery	Run chassis engine to recharge battery
		Blown fuses in battery compartment	Replace fuses
		40-amp breaker needs to be reset or cool down	Reset 40-amp breaker found near converter panel, either under dinette seat or rear bed
City Water Connection (p. 19)	City water connection leaks	Connection loose at coach	Tighten connection
		Rubber gasket missing from connected hose	Obtain a rubber gasket for hose at nearby hardware or RV store
Carbon Monoxide (CO) Detector (p. 18)	CO Detector chirping	Low coach battery	Run chassis to recharge coach batter
	Alarm sounds and will not reset	CO in coach. Chassis engine or generator has been running while windows are open	Shut off engine and/or generator and let coach air out and then reset detector
Coach Battery (p. 22)	Reading low on monitor	Coach battery is low	Run chassis to recharge coach battery

PROBLEM	SUB-PROBLEM	CAUSES	SOLUTIONS
Coach Battery (p. 22)	Rotten-egg smell	Battery emitting sulfur fumes due to short or over-charging of battery	Call Traveler's Assistance to schedule repair. Open all windows to keep unit aired out.
Coach Lighting (p. 23)	Lights are dim or not working	Dead or low coach battery 40-amp breaker is off	Run engine to charge coach battery Reset 40-amp breaker
Engine Ignition System (p. 9–10)	Engine cranks slowly or not at all	Poor chassis battery connection or low charge in chassis battery	Clean and/or tighten the battery terminals. Use emergency start switch on lower left corner dash under steering column while turning the ignition key.
	Key is stuck or will not turn	Steering while turned too far to either left or right Key is not in right position	Firmly rotate the steering wheel left or right until the key turns freely Turn ignition key all the way back and then turn one click forward
Fresh Water System (p. 41–42)	Fresh water tank will not fill	Tank is already full Fill pressure too high Attempting to fill tank through city water connection Hose not deep enough	Check monitor panel reading and run water. Turn down water on the fill hose Locate the separate connection labeled "Fresh/potable water". City water connection will not fill the fresh water tank. Push hose farther into fill hole
Furnace (p. 36–37)	Furnace blows no air	Fuse blown in converter Thermostat is turned off	Replace 15-amp fuse in converter or 2-amp fuse in thermostat (only available on some models) Turn furnace switch on
	Furnace blows cold air	Unit is out of LPG	Refill LPG tank

PROBLEM	SUB-PROBLEM	CAUSES	SOLUTIONS
Furnace (p. 36–37)	Furnace blows cold air	Main LPG tank is off	Turn on main LPG valve
		LPG detector is off	Reset LPG detector
		Air in LPG lines	Cycle furnace line on and off several times waiting 45 seconds between cycles
	Heats only when using external power source	Low coach battery	Run chassis to recharge coach battery
Gauges & Instrumentation (p. 2–4)	ABS light flashing or stays lit	Anti-lock brake system is disabled but normal braking is still effective	Call Traveler's Assistance to schedule repair
	Brake light is on	Parking brake may be on	Release parking brake
		Low brake fluid	Call Traveler's Assistance to schedule a repair
	ABS and Brake lights are both lit	Speed sensor malfunction	Call Traveler's Assistance to schedule a repair
		Combination of ABS problem plus park brake on or low brake fluid	Release the park brake or check and fill brake fluid and get service at next opportunity
	Service Engine Soon (SES) light stays on	One of the engines emission control systems may be malfunctioning	Vehicle may be running out of fuel
Poor quality fuel or water in fuel			
		Fuel cap may not have been properly installed or tightened.	
		If engine runs poorly and SES is lit call Traveler's Assistance to schedule service	
TOW/HAUL light is on or blinking	Overdrive is off	Reactivate overdrive	
	Transmission malfunction detected	Call Traveler's Assistance to schedule repair	

PROBLEM	SUB-PROBLEM	CAUSES	SOLUTIONS
GFCI Power Outlet (p. 23)	Reset button does not pop out when tested	Loss of ground fault protection	Call Traveler's Assistance to schedule service. Do not use outlets until problem is resolved
Generator (p. 25–27)	Circuit breaker trips	Overloaded circuit	Turn off some electrical load and reset circuit breaker
	Cranks fast but won't start	Not enough fuel in gas tank	Add fuel to chassis tank (fill above 3/8)
		Not enough fuel to generator	Prime generator by holding start button in off position for 10 seconds then try to start again.
		Low oil level	Add HD 30 or 10W-30 oil to generator
		Plugged fuel filter	Call Traveler's Assistance for repair
		Inoperative fuel pump	Call Traveler's Assistance for repair
		Fouled spark plug	Call Traveler's Assistance for repair
	Cranks slowly or not at all	Low coach battery	Start chassis then start generator
		Load connected	Disconnected load before starting
		Bad battery connection	Clean and/or tighten battery connections
		Blown fuse	Replace fuse on generator panel
	Generator runs then surges	Started with load on	Turn off all appliances and restart generator
	Starts and runs until button is released	Low oil level	Add HD 30 or 10W-30 oil to generator
		Malfunction in generator	Call Traveler's Assistance to schedule repair.
	Stops when driving around corners	Low fuel level	Refuel vehicle (above 3/8 tank)
		Low oil level	Add HD 30 or 10W-30 oil to generator
		Excess oil	Reduce generator oil level

PROBLEM	SUB-PROBLEM	CAUSES	SOLUTIONS
Holding Tanks (p. 43–44)	Holding tanks don't dump when valve handle is pulled	Tank contents frozen	Try to dump again after you have moved to a warmer climate (above 40°F)
	Holding tanks don't dump when valve handle is pulled	Dump valve blocked	Call Traveler's Assistance to schedule repair.
	Monitor panel says tank is full after it has been dumped	Debris is stuck on tank sensor	Pour two gallons of warm soapy water down shower for gray tank or toilet for black tank. When driving this should clean the sensor and give a proper reading
Kitchen Sink (p. 41–42)	Little or no water flow	Water pump is off	Turn on water pump at monitor panel
		Unit is out of water	Add water to the fresh water tank
		Clogged aerator	Unscrew faucet aerator and clean it
LPG System (p. 31–32)	L.P. is not flowing to amenities	Main tank valve not open	Open main tank valve
		LPG detector is off	Turn on/reset LPG detector
		Coach battery is dead	Run chassis engine to recharge or call Traveler's Assistance for service if battery wont recharge
		Low pressure in LPG tank	Add L.P. to main tank
		Freezing temperature not allowing LPG to vaporize	Move to a warmer location until LPG warms up
	LPG detector alarm activated or will not reset	Low coach battery	Run chassis engine to recharge battery
		Combustible fumes in area of detector	Air out coach and try to reset detector. If detector will not reset then turn off main LPG valve at tank and call Traveler's Assistance.
	Items blocking detector	Move items away from detector and reset if necessary	

PROBLEM	SUB-PROBLEM	CAUSES	SOLUTIONS
Microwave (p. 28)	Won't turn on	No 120-volt power to microwave	Turn on rooftop A/C. If RTAC works, check breakers in converter. If RTAC doesn't work and breakers are okay, check in the cabinet next to the microwave and make sure it is plugged in.
	Microwave turns on but no heat	Microwave is bad	Call Traveler's Assistance to discuss options
Monitor Panel (p. 22)	No lights on panel	Blown fuse	Check fuse at power converter marked "monitor panel". Change if necessary.
		40-amp Breaker	Reset 40-amp breaker
		Dead battery	Run chassis engine to recharge coach battery. If it is still not working, call Traveler's Assistance to schedule service.
Refrigerator (p. 33–34)	Check light on	LPG valve is closed	Open main tank valve
		Temperature slider disconnected	Make sure temperature slider is connected to the fin inside the fridge and wire is attached.
		Clogged LPG igniter	Cycle lines: Turn fridge on for 30 seconds and off for 30 seconds. Do this 5 or 6 times.
		Tripped high temperature limit switch	(Some models) Locate exterior fridge panel. Remove panel and locate small red reset button attached to the side of the ignition tube. Push button and replace cover.

PROBLEM	SUB-PROBLEM	CAUSES	SOLUTIONS
Refrigerator (p. 33–34)	Refrigerator doesn't turn on	Low or dead coach battery	Run chassis engine to recharge coach battery
	Refrigerator doesn't work on LPG	Air in the LPG line	Cycle lines: turn fridge on and off for 30 seconds, 5 to 6 times
		Other LPG problem	Troubleshoot LPG system
	Refrigerator doesn't work on 120-volt mode	Circuit breaker tripped	If microwave clock is on, check the breakers in the converter
		No 120-volt power to coach	Troubleshoot 120-volt system
Rooftop A/C (p. 29–30)	A/C doesn't run	No 120-volt power to A/C	Make sure if using generator power that the shoreline is plugged into compartment. If using external 30-amp connection make sure breaker for power is in the "ON" position. If microwave works, check breaker in converter for RTAC.
		Cooling coils inside A/C are frozen	Turn off A/C and let stand for 45–60 minutes to allow thawing
Shower (p. 41–44)	Shower faucet on but no water coming out	Knob at back of shower head is turned off.	Turn knob/push button at back of showerhead
		Knob spins freely	Remove cap in middle of shower knob and tighten the screw inside
	Water backing up into shower	Gray water tank is full	Empty gray water tank

PROBLEM	SUB-PROBLEM	CAUSES	SOLUTIONS
Shower (p. 41–44)	Water backing up into shower	Clogged drain/drain cover	Clean drain cover and clear shower pipe to release water. No chemicals can be used as they can cause damage to the piping of the vehicle.
Stove Top (p. 35)	LPG flowing out of burner but not lighting	Manual lighter inoperative	Use matches/lighter to light the stove
		Igniter lead has come off lighter	Lift stove top and reconnect orange lead to back of lighter or use matches/lighter to light the stove
	Stove burner won't light and no LPG flowing	LPG is empty	Refill LPG tank
		Main LPG valve is off	Turn main LPG valve on
Thermostat (p. 30, 36–37)	Won't operate and error code showing on thermostat	E1	Call Traveler's Assistance for service
		E2	Thermostat too hot to operate properly due to outdoor temperature. Hold up a cold bottle of water or ice under the thermostat for 30 seconds or until the code goes away.
		E3	Call Traveler's Assistance for service
		E4	Turn off A/C and let stand for 45–60 minutes to allow thawing of cooling coils
		E5	Call Traveler's Assistance for service
Toilet (p. 43)	No water to toilet	Water pump not on	Turn on water pump at monitor panel
		Fresh water tank empty	Fill fresh water tank

PROBLEM	SUB-PROBLEM	CAUSES	SOLUTIONS
Water Heater (p. 38–39)	Red light comes on and stays on	LPG not lighting	Cycle lines: Turn water heater switch on for 30 seconds and off for 30 seconds repeat 5-6 times
		Out of LPG	Refill LPG tank
		Main LPG valve is off	Turn on main LPG valve
	Red light doesn't come on	Water is already hot	Check faucet for hot water
		Fuse blown	Check 15-amp fuse in converter
	Leaking at the relief valve	Common due to expansion after water heater heats up water to operating temperature	Use some hot water from the system and this should help relieve the pressure
		Debris in relief valve	Open and close relief valve. CAUTION: WATER WILL RUSH OUT AND COULD BE VERY HOT
	Water heater is on but water is not hot	Bypass valve may be open	Close bypass valve
Water Pump (p. 41–42)	Water pump not pumping	Low or dead coach battery	Run chassis engine to recharge battery
		Fresh water tank empty	Fill fresh water tank
		Water pump is not on	Turn on water pump at monitor panel
		Water pump jammed	Call Traveler's Assistance for service

RETURNING THE MOTORHOME

Before you return your motorhome, please be prepared. This will avoid the possibility of being charged for any of the following:

1. Remember to return the unit at least as clean as it was when you rented it or you will be charged a cleaning fee.
2. Remember to return the unit with the waste tanks empty, valves open and the waste cap off (where permitted by law) or you will be charged a dumping fee.
3. Remember to return the unit with at least the same amount of fuel and L.P. as it had when you rented it or you will be charged a refueling fee.
4. Remember to return the unit at the date, time and place indicated on your copy of "Rental Agreement: Check Out" (the document you signed when you picked up your RV) or you may be charged an hourly late fee. It is recommended that the vehicle be returned during normal business hours and the Rental Agreement should be finalized while you are present.
5. When you return, you must report and pay for traffic/parking violations or you will be charged an administration fee.

Contact your rental return location for fee amounts. These points and more can be found in "Rental Agreement: Check Out" and in the "Additional Terms and Conditions of Rental Contract" (a folded document given to you along with your copy of "Rental Agreement: Check Out") and/or the signed vehicle acceptance form.

RENTER ASSISTANCE GUIDE



BE THERE NOW.

We want to ensure you have an enjoyable experience with Cruise America. Please use this guide to acquaint yourself with your vehicle and avoid or solve issues that you may face during your trip. If, at any time, you need assistance, please call our Traveler's Assistance number at 1-800-334-4110.