

CLASS C, B+, & GAS CLASS A



THOR
MOTOR COACH



Congratulations on your recent purchase of a Thor Motor Coach Recreational Vehicle. We sincerely thank you for choosing and putting your faith in Thor Motor Coach. We want you to know that your satisfaction is of great importance to us. Our major goal is to provide you with a quality recreational vehicle at a reasonable price.

This manual will help you better understand the features and operating performances of your recreational vehicle. Please read it and keep it in your vehicle for future reference.

Our customers are extremely important to us, and we want to assure you that we will always strive to do everything possible to continue to earn your trust and goodwill.

Welcome to the wonderful world of RVing and the Thor Motor Coach family.

Happy Travels!

This page intentionally left blank

Registration And Acknowledgement of Receipt of Warranty and Product Information v122010a



IMPORTANT: THE PURCHASER IS REQUIRED TO READ THIS DOCUMENT BEFORE SIGNING IT.

We have listed several items which will help acquaint you with your new recreation vehicle. You the purchaser, should not submit this form until (1) you have received and reviewed the Limited Warranty and owner's manual; (2) you have had the opportunity to inspect and operate the vehicle; (3) all items have been demonstrated and/or explained to you; (4) the dealer has answered any questions you may have, and; (5) you find the vehicle in good condition, acceptable to purchaser. The dealer is not authorized to deliver this vehicle until this has been done and both you and the dealer have signed this form.

PRODUCT LINE _____		SERIAL NUMBER _____	
YEAR _____		VIN NUMBER _____	
PURCHASER'S LAST NAME _____		PURCHASER'S FIRST NAME _____	
CO-PURCHASER'S LAST NAME _____		CO-PURCHASER'S FIRST NAME _____	
STREET ADDRESS _____		CITY _____	
STATE _____	ZIP _____	COUNTRY _____	PHONE _____
PURCHASER'S EMAIL _____		RETAIL DELIVERY DATE _____	

Owner/Dealer Inspection

- | | |
|--|--|
| 1. Exterior and interior finish | 5. Operate plumbing facilities including water faucet's, shower and toilet |
| 2. Operate all appliances (electrical and gas) | 6. Observe or check to assure that all wheel lugs are tight and tire pressure is correct |
| a. Furnace and thermostat | 7. Review operation of manual or automatic Propane Gas regulator |
| (lighting and maintenance) | 8. Operate all air conditioners, radio, entertainment system and televisions |
| b. Range and oven (lighting and maintenance) | (if so equipped) |
| c. Water heater (lighting and maintenance) | 9. Complete review of owner's manual by dealer with owner |
| d. Refrigerator (operation and maintenance) | 10. Test drive |
| 3. Operate 120 Volt generator (if so equipped) | 11. Odometer reading as observed by customer is: _____ |
| 4. Operate all doors and windows including locks | 12. Obtain answers to any questions you may have _____ |

MILES OR KILOMETERS

I have completed the above inspection on this recreation vehicle and have taken the test drive at the time of purchase. I noted the following issues:

Before I purchased this vehicle, I received, read and agreed to the terms and conditions of Thor Motor Coach's 1 page Limited Warranty, published within its Owner's Manual, and the Chassis Limited Warranty. I understand and agree that any legal action for breach of express or for breach of implied warranties that may arise by operation of law must be filed within ninety (90) days of the expiration of the applicable warranty coverage period as defined within the limited warranty. I agree that the vehicle is to be used only for travel on improved roads. I also agree that the selling dealer is not an agent for Thor Motor Coach but is an independent company with no authority to make any representation or promise for Thor Motor Coach.

I understand and acknowledge that the chassis and component parts and appliances that are exclusively covered by the warranty issued by the manufacturer of the chassis and warranty issued by the manufacturer of the component part and appliance; Thor Motor Coach's limited warranty excludes the chassis and component parts and appliances that are warranted by their manufacturer. I understand that this form is for product registration purposes and failure to return this form does not diminish my warranty rights during the warranty period.

By signing the line below, I acknowledge and agree that I have: inspected or been given the opportunity to inspect the vehicle; taken a test drive of the vehicle and made notations of any issues I discovered in the space provided.

_____ PURCHASER SIGNATURE	_____ DATE	_____ DEALER SIGNATURE	_____ DATE
------------------------------	---------------	---------------------------	---------------

_____ SALES PERSON LAST NAME	_____ SALES PERSON FIRST NAME
---------------------------------	----------------------------------

_____ SELLER DEALER	_____ DATE
------------------------	---------------

TAPE - PLEASE DO NOT STAPLE

FOLD HERE

PLACE STAMP HERE

THOR MOTOR COACH
P.O. Box 1486
ELKHART, INDIANA 46516

FOLD HERE

TAPE - PLEASE DO NOT STAPLE

Table of Contents

Introduction	7	Living Room Television	56
How to Use this Manual	7	Doors & Drawers	56
Reporting Safety Defects	7	Under Bed Storage	56
Warranty	9	Sleep Number Bed	56
Production changes	13	Sofa/Hide-A-Bed	57
Owner Responsibility	13	Barrel Chair	58
Major Equipment Suppliers	15	Dinette	58
Planning and Preparation	17	Chairs	59
Read the Book	17	Bedroom Door & Latch	59
Licenses	17	Day/Night Shade	59
Insurance	17	Water Heater Switch	59
Inspect and Maintain	17	Kitchen Cabinets	60
Loading and Weight Distribution	17	Kitchen Drawers	60
Control of the Motorhome	17	Kitchen Pantry	60
Pre-Travel Check	17	Range	60
Opening Checklist	18	Refrigerator	60
Weights	20	Microwave	60
Weighing Your Motorhome	21	Kitchen Sink	60
Identification and Safety	25	Kitchen Faucet	61
Laws of the Road	25	Shower Head & Hose	61
Fire Safety	26	Elevated Beds	61
Fire Extinguisher	26	Entry Door	62
Smoke Detector	27	Assist Handle	62
Carbon Monoxide Detector	27	Electric Step	63
Carbon Monoxide Safety Precautions	29	Compartment Doors & Storage Compartments	64
LP Safety	29	Rear Ladder	64
LP Gas Detector	30	Awnings	65
Chemical Sensitivity	32	Cable Hookup/Phone Jack	66
Seat Belts	33	Generator Compartment	66
Egress Window	34	Furnace Door	66
Trailer Towing	34	Water Heater Door	66
Chassis	37	Refrigerator Door	66
Emergency Stopping	37	Entertainment	68
Engine and Drive Train	37	Television	68
Fueling the Motorhome	38	Home Theater System	68
Travel Preparation	38	Exterior Entertainment Center	68
On the Road Safety	41	Video Switch Box	68
Fuel System	41	TV Hook-up	68
Driving	41	Sample A/V Hook-up Diagrams	68
Parking	41	Heating and Air Conditioning	71
Changing Tires	42	Dash Panel Heater and Air Conditioner	71
Tire Care	42	Roof Mounted Air Conditioner	72
Check Air Pressure	42	Furnace	72
Controls and Operations	45	Thermostats	73
Automotive Dash	45	Ceiling Vents	73
Gear Selector	45	Electrical Systems	75
Dash Controls	45	Shore Cord	75
Steering Wheel Adjustment	47	Batteries	76
Turn Signal/Lane Change	47	Power converter	79
Hazard Flasher Control	47	Ground Fault Circuit Interrupter	79
Rear Vision System	48	12V System Fuses	80
Dash Radio	49	Circuit Breakers	80
Automatic Hydraulic Power Levelers	50	System Panels	81
Slide Outs	54	Chassis Alternator	82
Windows	55	Generator	82
Storage Above Cockpit	56		

Table of Contents

Water Systems	85	Pre-Finished Panels	108
Fresh Water System	85	Mold	108
Low Point Drains	87	Winter Use and Storage	113
Sanitizing the System	87	Tips for Winter Use	113
Monitor Panel	88	Water System	113
Waste Water System	88	Food Storage	113
Heated Holding Tanks	89	Propane System	113
Dumping the Holding Tanks	89	Heating	113
How to Prevent Blockage of Drain Lines	89	Condensation	113
Termination Compartment Components	90	Winterization Procedure	113
Toilet	90	Water Heater Bypass	115
LP System	93	Winterization Checklist	115
Propane Gas Tank	93	Travel Preparation Checklist	118
Propane Regulator	94	Maintenance Schedule	119
Propane Gas Hoses	95	Fuel/Oil Record	122
Propane Gas Safety	96	Notes	124
Care and Maintenance	97	Index	126
Batteries	97		
Water System	98		
Waste Water System	98		
Fresh Water System	98		
Electrical System	98		
Generator Power System	98		
Propane System	99		
ABS Plastic Parts	99		
Alignment	99		
Awning	99		
Chassis	100		
Exterior Lights	100		
Fiberglass	101		
Exterior Graphics/Paint	102		
Extrusions and Aluminum Surfaces	103		
Roof	103		
Roof Vents	104		
Seals & Adhesives	104		
Slide Out	105		
Tires & Rims	105		
TV Antenna	105		
Underbody	106		
Windows & Doors	106		
Hydraulic Fluid	106		
Appliances	106		
Bath Fixtures	106		
Bathtub Seal	107		
Bedsprad & Draperies	107		
Carpet	107		
High Pressure Laminate Countertop	107		
Hardware	107		
Kitchen Fixtures	107		
Blinds & Shades	107		
Sinks	107		
Solid Surface Countertop	107		
Upholstery & Fabrics	108		
Wall Coverings	108		

How to Use This Manual

Your motorhome has been thoroughly inspected before shipment to the dealer. Your selling dealer is responsible for performing a complete pre-delivery inspection of all motorhome components as specified in the pre-delivery checklists supplied by the manufacturer. You should receive a copy of these completed checklists from your dealer when the motorhome is delivered to you.

Should a problem arise, your first step is to contact your selling Thor Motor Coach dealer who will be glad to handle your situation. This Owner's Manual is not intended for use as a service manual, but rather as a guide to help you become familiar with your motorhome.

This manual is not model specific, which means that it is used for a variety of different models that Thor Motor Coach manufactures. It is of a general nature, so the illustrations and descriptions may not be exactly as they are in your particular motorhome.

If you are unclear or unfamiliar with any procedure that is described in this manual, see your Thor Motor Coach dealer for further clarification before proceeding.

Thor Motor Coach uses the following notations to warn the user of possible safety concerns and to provide information that will prevent personal injury to the user and/or damage to the motorhome.

⚠ WARNING A WARNING INDICATES A POTENTIALLY HAZARDOUS SITUATION THAT, IF NOT AVOIDED, MAY RESULT IN DEATH OR SERIOUS INJURY.

⚠ CAUTION A CAUTION INDICATES A POTENTIALLY HAZARDOUS SITUATION THAT, IF NOT AVOIDED, MAY RESULT IN MINOR OR MODERATE INJURY.



NOTE:

A NOTE INDICATES AN INSTRUCTION OR PROCEDURE THAT IS IMPORTANT FOR PROPER SERVICE. A NOTICE CAN ALSO SUPPLY INFORMATION THAT WILL HELP TO MAKE YOUR CAMPING EXPERIENCE MORE PLEASANT.

⚠ DANGER A DANGER INDICATES AN IMMINENTLY HAZARDOUS SITUATION THAT, IF NOT AVOIDED, WILL RESULT IN DEATH OR SERIOUS INJURY.

REPORTING SAFETY DEFECTS

If you believe that your vehicle has a defect, which could cause an accident, injury, or death, you should immediately inform the National Highway Traffic Safety Administration (NHTSA) in addition to notifying Thor Motor Coach.

If NHTSA receives similar complaints, it may open an investigation, and if it finds that a safety defect exists in a group of vehicles, it may order a recall and remedy campaign. However, NHTSA cannot become involved in individual problems between you and your dealer or Thor Motor Coach.

To contact NHTSA, you may either call the Vehicle Safety Hotline toll free at 888-327-4236, TTY: 800-424-9153, or write to: Administrator, NHTSA, 1200 New Jersey Avenue S.E., Washington DC, USA 20590. You can go to the NHTSA website, www.safercar.gov. You can also obtain other information about motor vehicle safety from the Hotline.

Introduction

This manual describes many features of your motorhome and provides a guide to operating procedures so that you can obtain the best performance from those features. Your motorhome has been designed to conform with, or exceed, the American National Standards Institute A 119.2, NFPA 1192, CANADIAN CAN/CSA-Z240 RV SERIES-99 (Canadian-built or units built for Canada), and applicable motor vehicle safety standards. These standards establish the plumbing, heating, electrical and other requirements for quality and safety. The seal attached just outside the entry door indicates compliance with these standards. This seal is the outward sign of internal quality.

Like all automotive equipment, your motorhome will require care and regular maintenance in order to retain its maximum performance characteristics. This manual, along with the specific instructions provided by the leading appliance manufacturers, are in your Owner's Information Kit. The Chassis Operator's Manual outlines important areas of service and provides a maintenance schedule. Please follow them carefully to ensure a safe trouble-free service. Study these instructions carefully. A good working knowledge of your unit and how to care for it will help you enjoy many miles and years of recreational living.

If you have any questions regarding operation, maintenance, or service, please contact your dealer immediately so they can assist you. Your dealer's Service or Sales Department is equipped to handle most any problem that may occur. Customer service is of the utmost importance to your dealer and is just as important to the manufacturer. This manual contains a section outlining the warranty and explaining your rights and obligations, as well as the rights and obligations of the dealer and manufacturer, under the terms of the warranty. Please read this section carefully. You will be better informed in case you have a warranty related problem and your dealer will be better able to get you back on the road again in a timely manner.

We sincerely believe that your dealer and the factory representative will be able to solve any problem which may arise. If their combined efforts are not satisfactory, please send a letter describing the circumstances to:

Thor Motor Coach
PO Box 1486
Elkhart IN 46515-1486

Thor Motor Coach Customer Service is the support arm for Thor Motor Coach, and was developed to streamline technical assistance, warranty claims, authorization requests, and parts for our dealer network and owners. This will greatly improve our business relationship with you, and our dealer network, and in the event of a problem, will get you back on the road again in a timely manner.

You must include the dealer's name as well as the model and serial number of your motorhome. The Thor Motor Coach serial number is located on the bottom of the federal sticker, which is located in the driver's compartment area. Thank you for choosing our product. Your dealer and we, the manufacturer, will continually strive to merit your confidence.

⚠ CAUTION Some equipment and features described or shown in this manual may be optional on your model. This instructional manual is of a general nature only. Because of the continuous process of product improvement conducted by Thor Motor Coach, it is possible that recent product changes may not be included in this manual. Specifications may change without notice. This manual is accurate as of the date of publication. The instructions included in this manual are intended as a guide, and in no respect extend the responsibilities of the manufacturing subsidiary, parent company or affiliates beyond the standard written warranty as presented in this manual.



Note:

Photographs or illustrations in this manual are representative of function and may or may not be specific in their depiction of actual equipment, fabrics, interior or exterior decor, or design options as installed on or in your motorhome.

⚠ CAUTION This product is designed to provide temporary living quarters for recreational, camping, or travel. Use of this product for long term or permanent occupancy may lead to premature deterioration of interior finishes, fabrics, carpeting, drapes, or components. Damage or deterioration due to long term occupancy may not be considered normal, and may under the terms of the warranty, constitute misuse, abuse, or neglect, and may therefore reduce or void certain warranty protection.

Warranty

THOR MOTOR COACH'S LIMITED WARRANTY

WHAT THE PERIOD OF COVERAGE IS:

This Limited Warranty provided by Thor Motor Coach, Inc. ("Warrantor") covers those components, assemblies and systems of your new motorhome not excluded under the section "What is Not Covered" when sold by an authorized dealer. The duration of the limited warranty ends twelve (12) months after your first take delivery of the motorhome from an authorized dealership or after the odometer reaches 15,000 miles, whichever occurs first. However, this Limited Warranty provided by Warrantor covers the steel or aluminum frame structure, only, of the sidewalls (excluding slide outs), roof, and rear and front walls for twenty-four (24) months from the original retail purchase date or the first 24,000 miles of use, whichever occurs first. Warrantor's Limited Warranty is not transferable and only applies to the first retail owner of the motorhome.

If the motorhome is not of the current or prior model year when you take delivery of the motorhome OR you register your new motorhome in a business name or use your motorhome for any commercial or business purposes other than for rental purposes, the duration of the limited warranty ends ninety (90) days after your first take delivery of the motorhome or after the odometer reaches 5,000 miles, whichever occurs first. The duration of the Limited Warranty covering the steel or aluminum frame structure, only, of the sidewalls (excluding slide outs), roof, and rear and front walls ends twelve (12) months after your first take delivery of the motorhome or after the odometer reaches 15,000 miles, whichever occurs first. A conclusive presumption that your motorhome has been used for commercial and/or business purposes arises if you have filed a federal or state tax return claiming any business tax benefit related to your ownership of the motorhome.

LIMITATION AND DISCLAIMER OF IMPLIED WARRANTIES:

IMPLIED WARRANTIES, IF ANY ARISING BY WAY OF STATE LAW, INCLUDING ANY IMPLIED WARRANTY OF MERCHANTABILITY AND ANY IMPLIED WARRANTY OF FITNESS FOR A PARTICULAR PURPOSE, ARE LIMITED IN DURATION TO THE TERM OF THIS LIMITED WARRANTY AND ARE LIMITED IN SCOPE OF COVERAGE TO THOSE PORTIONS OF THE MOTORHOME COVERED BY THIS LIMITED WARRANTY. WARRANTIES, INCLUDING ALL IMPLIED AND EXPRESS WARRANTIES, INCLUDING THE IMPLIED WARRANTY OF MERCHANTABILITY AND THE IMPLIED WARRANTY OF FITNESS FOR A PARTICULAR PURPOSE, ON COMPONENTS AND APPLIANCES EXCLUDED FROM COVERAGE AS SET FORTH BELOW. There is no warranty of any nature made by Warrantor beyond that contained in this Limited Warranty. No person has authority to enlarge, amend or modify this Limited Warranty. The dealer is not the Warrantor's agent but is an independent entity. Warrantor is not responsible for any undertaking, representation or warranty made by any dealer or other person beyond those expressly set forth in this Limited Warranty. Some states do not allow limitations on how long an implied warranty lasts, so the above limitation may not apply to you.

WHAT THE WARRANTY COVERS:

Warrantor's limited Warranty covers only defects in the workmanship performed and/or materials used to assemble those portions of your motorhome covered by the limited warranty. See also the section "What the Warranty Does Not Cover" set out below. "Defect" means the failure of the workmanship performed and/or materials used to conform to Warrantor's design and manufacturing specification and tolerances.

WHAT WE WILL DO TO CORRECT PROBLEMS:

Warrantor's sole and exclusive obligation is to repair and/or replace, at its option, any covered defect if: (1) you notify Warrantor and one of its authorized servicing dealers of the defect, which is discovered within the warranty coverage period, within ten (10) days of discovering the defect; and (2) you deliver your Motorhome to Warrantor or Warrantor's authorized servicing dealer at your cost and expense. It is reasonable to expect some service items to occur during the warranty period. Unless prohibited by state law, the performance of warranty repairs shall not extend the original warranty coverage period. Further, any performance of repairs after the warranty coverage period has expired or any performance of repairs to component parts and appliances that are excluded from coverage shall be considered "good will" repairs, which shall not alter the express terms of this limited warranty. If the repair or replacement remedy fails to successfully cure a defect after Warrantor received a reasonable opportunity to cure the defect(s), your sole and exclusive remedy shall be limited to Warrantor paying you the cost of having an independent third party perform repairs to the defect(s) or diminution in value damages if defect(s) are incurable. Warrantor may use new and/or remanufactured parts and components of substantially equal quality to complete any repair. Defects and/or damage to interior and exterior surfaces, trim, upholstery and other appearance items may occur at the factory during manufacture, during delivery of the motorhome to the selling dealer or on the selling dealer's lot. Normally, any such defect or damage is detected and corrected at the factory or by the selling dealer during the inspection process performed by the Warrantor and the selling dealer. If, however, you discover any such defect or damage when you take delivery of the motorhome, you must notify your dealer or Warrantor within ten days of the date of purchase to have repairs performed to the defect at no cost to you as provided by this Limited Warranty. If two unsuccessful repair attempts have been made to correct any covered defect that you believe substantially impairs the value, use or safety of your motorhome, or repairs to any covered defect(s), which you believe substantially impairs the value, use or safety of your motorhome, have taken 20 or more days to complete, you must, to the extent permitted by law, notify Warrantor directly in writing of the failure to successfully repair the defect(s) so that Warrantor can become directly involved in exercising a final repair attempt for the purpose of performing a successful repair to the identified defect(s).

Minor adjustments, such as adjustments to the interior or exterior doors, drawers, latches by way of example and not by limitation will be performed by your selling dealer during the first ninety (90) days of warranty coverage. Thereafter, such adjustments are the owner's exclusive responsibility as normal maintenance.

HOW TO GET SERVICE:

The Acknowledgement of Receipt of Warranty/Product Information form must be returned to Warrantor promptly upon purchase to

assure proper part replacement and repair of your motorhome. Failure to return the "Acknowledgement of Receipt of Warranty/Product Information" form will not affect your rights under the Limited Warranty so long as you can furnish proof of purchase. For warranty service simply contact one of Warrantor's authorized service centers for an appointment, then deliver your motorhome (at your expense) to the service center.

If you need assistance in locating an authorized warranty service facility, contact Warrantor's Warranty Department (877-855-2867). The mailing address is: **P. O. Box 1486, Elkhart, Indiana 46515-1486**

WHAT THE WARRANTY DOES NOT COVER:

This Limited Warranty does not cover any motorhome used for rental purposes and any motor home sold or registered outside of the United States or Canada; items which are added or changed after the motorhome leaves Warrantor's possession; items that are working as designed but with which you are unhappy with because of the design; normal wear and usage, such as fading or discoloration of fabrics, or the effects of moisture inside the motorhome; denting, scratching, dents and chips on any surface or fabric of the motorhome, not caused by Warrantor; owner maintenance, including by way of example replacement of wiper blades, bulbs, filters, wheel alignments and resealing exterior sealant areas (See Care and Maintenance Section of Owner's Manual); the automotive chassis and power train, including by way of example the engine, drive-train, steering, ride and handling, braking, wheel balance, muffler, tire wear or failure, tubes, batteries and gauges; appliances and components covered by their own manufacturers' warranty including, by way of example the microwave, refrigerator, ice maker, stove, oven, generator, roof air conditioners, hydraulic jacks, VCR, television(s), water heater, furnace, stereo, radio, compact disc player, washer, dryer, inverter and cellular phone; or flaking, peeling and chips or other defects or damage in or to the exterior or finish caused by rocks or other road hazards, the environment including chemical off-gassing, airborne pollutants, salt, tree sap and hail causing any damage including but not limited to corrosion. Component part and appliance manufacturers issue limited warranties covering those portions of the motorhome not covered by the Limited Warranty issued by Warrantor. To learn more on what specific component parts and appliances are excluded from the Limited Warranty issued by Warrantor please contact your selling dealership or Warrantor directly or review the warranty packet inside the Motorhome.

EVENTS DISCHARGING WARRANTOR FROM OBLIGATION UNDER WARRANTY:

Misuse or neglect; accidents, unauthorized alteration, failure to provide reasonable and necessary maintenance (see Owner's Manual); damage caused by off road use, collision, fire, theft, vandalism, explosions, overloading in excess of rated capacities, and odometer tampering shall discharge Warrantor from any express or implied warranty obligation to repair any resulting defect.

DISCLAIMER OF CONSEQUENTIAL AND INCIDENTAL DAMAGES:

THE ORIGINAL PURCHASER OF THE MOTORHOME AND ANY PERSON TO WHOM THE MOTORHOME IS TRANSFERRED, AND ANY PERSON WHO IS AN INTENDED OR UNINTENDED USER OR BENEFICIARY OF THE MOTORHOME, SHALL NOT BE ENTITLED TO RECOVER FROM WARRANTOR ANY CONSEQUENTIAL OR INCIDENTAL DAMAGES RESULTING FROM ANY DEFECT IN THE MOTORHOME, INCLUDING BY WAY OF EXAMPLE FUEL AND TRANSPORTATION EXPENSES TO DELIVER THE PRODUCT TO THE SERVICING DEALER, HOTEL ROOMS, LOST WAGES AND MOISTURE DAMAGE SUCH AS MOLD AND MILDEW. THE EXCLUSION OF CONSEQUENTIAL AND INCIDENTAL DAMAGES SHALL BE DEEMED INDEPENDENT OF, AND SHALL SURVIVE, ANY FAILURE OF THE ESSENTIAL PURPOSE OF ANY LIMITED REMEDY. Some states do not allow the exclusion or limitation of consequential or incidental damages, so the above exclusions may not apply to you.

LEGAL REMEDIES:

THIS LIMITED WARRANTY DOES NOT EXTEND TO FUTURE PERFORMANCE. ANY ACTION TO ENFORCE THIS LIMITED WARRANTY OR ANY IMPLIED WARRANTIES SHALL NOT BE COMMENCED MORE THAN 90 DAYS AFTER THE EXPIRATION OF THE APPLICABLE WARRANTY COVERAGE PERIOD DESIGNATED ABOVE. IF YOUR MOTORHOME IS NOT OF THE CURRENT OR PRIOR MODEL YEAR WHEN YOU TAKE DELIVERY OF THE MOTORHOME OR YOU USE YOUR MOTORHOME FOR COMMERCIAL OR BUSINESS PURPOSES OTHER THAN FOR RENTAL PURPOSES, ANY ACTION TO ENFORCE THIS LIMITED WARRANTY OR ANY IMPLIED WARRANTIES SHALL NOT BE COMMENCED MORE THAN ONE YEAR AFTER THE EXPIRATION OF THE APPLICABLE WARRANTY COVERAGE PERIOD DESIGNATED ABOVE. UNLESS PROHIBITED BY STATE LAW, THE PERFORMANCE OF REPAIRS SHALL NOT SUSPEND THIS LIMITATIONS PERIOD FROM EXPIRING AND ANY LEGAL ACTION TO ENFORCE WARRANTY RIGHTS AGAINST WARRANTOR MUST BE BROUGHT WITHIN THE STATE OF INDIANA. Some states do not allow the reduction in the statute of limitations, so the above reduction in the statute of limitations may not apply to you.

Warrantor participates in the Consumer Arbitration Program for Recreational Vehicles (CAP-RV) operated by Dealers & Associates. The CAP-RV program operates as a certified mechanism under the review of the California Arbitration Certification Program. You must utilize the arbitration program before claiming rights conferred by 15 USC section 2310 (Uniform Commercial Code) or Civil Code section 1793.222(b) (Tanner Act). You are not required to use the program if you choose to seek redress by pursuing rights and remedies not created by those laws. To find out more about the program or to request an application brochure please call the Arbitration Administrator Office toll free (800) 279-5343. Members of the Armed Forces who purchased the vehicle in California, or who were stationed in or a resident of California at the time of purchase (regardless of state of purchase) or who are stationed in California at the time of application to this program, may utilize the CAP-RV program.

THIS WARRANTY GIVES YOU SPECIFIC LEGAL RIGHTS. YOU MAY ALSO HAVE OTHER RIGHTS, WHICH VARY FROM STATE TO STATE. Julian Date: 04/29/13

Warranty

WHAT THE PERIOD OF COVERAGE IS:

This Limited Warranty provided by Thor Motor Coach, Inc.® (“Warrantor”) covers those components, assemblies and systems of your new motorhome not excluded under the section “What is Not Covered”, when sold by an authorized dealer. The duration of the limited warranty ends twelve (12) months after you first take delivery of the motorhome from an authorized dealership or after the odometer reaches 15,000 miles, whichever occurs first. However, this Limited Warranty provided by Warrantor covers the steel or aluminum frame structure, only, of the sidewalls (excluding slide outs), roof, and rear and front walls for twenty-four (24) months from the original retail purchase date or the first 24,000 miles of use, whichever occurs first. Warrantor’s Limited Warranty is not transferable and only applies to the first retail owner of the motorhome.

If the motorhome is not of the current or prior model year when you take delivery of the motorhome OR you register your new motorhome in a business name or use your motorhome for any commercial or business purposes other than for rental purposes, the duration of the limited warranty ends ninety (90) days after you first take delivery of the motorhome or after the odometer reaches 5,000 miles, whichever occurs first. The duration of the Limited Warranty covering the steel or aluminum frame structure, only, of the sidewalls (excluding slide outs), roof, and rear and front walls ends twelve (12) months after you first take delivery of the motorhome or after the odometer reaches 15,000 miles, whichever occurs first. A conclusive presumption that your motorhome has been used for commercial and/or business purposes arises if you have filed a federal or state tax form claiming any business tax benefit related to your ownership of the motorhome.

LIMITATION AND DISCLAIMER OF IMPLIED WARRANTIES:

IMPLIED WARRANTIES, IF ANY, ARISING BY WAY OF STATE LAW, INCLUDING ANY IMPLIED WARRANTY OF MERCHANTABILITY AND ANY IMPLIED WARRANTY OF FITNESS FOR A PARTICULAR PURPOSE, ARE LIMITED IN DURATION TO THE TERM OF THIS LIMITED WARRANTY AND ARE LIMITED IN SCOPE OF COVERAGE TO THOSE PORTIONS OF THE MOTORHOME COVERED BY THIS LIMITED WARRANTY. WARRANTOR DISCLAIMS ALL IMPLIED AND EXPRESS WARRANTIES, INCLUDING THE IMPLIED WARRANTY OF MERCHANTABILITY AND THE IMPLIED WARRANTY OF FITNESS FOR A PARTICULAR PURPOSE, ON COMPONENTS AND APPLIANCES EXCLUDED FROM COVERAGE AS SET FORTH BELOW. There is no warranty of any nature made by Warrantor beyond that contained in this Limited Warranty. No person has authority to enlarge, amend or modify this Limited Warranty. The dealer is not the Warrantor’s agent but is an independent entity. Warrantor is not responsible for any undertaking, representation or warranty made by any dealer or other person beyond those expressly set forth in this Limited Warranty. Some states do not allow limitations on how long an implied warranty lasts, so the above limitation may not apply to you.

WHAT THE WARRANTY COVERS:

Warrantor’s Limited Warranty covers only defects in the workmanship performed and/or materials used to assemble those portions of your motorhome covered by the limited warranty. See also the section “What the Warranty Does Not Cover” set out below. “Defect” means the failure of the workmanship performed and/or materials used to conform to Warrantor’s design and manufacturing specification and tolerances.

WHAT WE WILL DO TO CORRECT PROBLEMS:

Warrantor’s sole and exclusive obligation is to repair and/or replace, at its option, any covered defect if: (1) you notify Warrantor and one of its authorized servicing dealers of the defect, which is discovered within the warranty coverage period, within ten (10) days of discovering the defect; and (2) you deliver your Motorhome to Warrantor or Warrantor’s authorized servicing dealer at your cost and expense. It is reasonable to expect some service items to occur during the warranty period. Unless prohibited by state law, the performance of warranty repairs shall not extend the original warranty coverage period. Further, any performance of repairs after the warranty coverage period has expired or any performance of repairs to component parts and appliances that are excluded from coverage shall be considered “good will” repairs, which shall not alter the express terms of this limited warranty. If the repair or replacement remedy fails to successfully cure a defect after

Warrantor received a reasonable opportunity to cure the defect(s), your sole and exclusive remedy shall be limited to Warrantor paying you the cost of having an independent third party perform repairs to the defect(s) or diminution in value damages if defect(s) are incurable. Warrantor may use new and/or remanufactured parts and/or components of substantially equal quality to complete any repair. Defects and/or damage to interior and exterior surfaces, trim, upholstery and other appearance items may occur at the factory during manufacture, during delivery of the motorhome to the selling dealer or on the selling dealer's lot. Normally, any such defect or damage is detected and corrected at the factory or by the selling dealer during the inspection process performed by the Warrantor and the selling dealer. If, however, you discover any such defect or damage when you take delivery of the motorhome, you must notify your dealer or Warrantor within ten days of the date of purchase to have repairs performed to the defect at no cost to you as provided by this Limited Warranty. If two unsuccessful repair attempts have been made to correct any covered defect that you believe substantially impairs the value, use or safety of your motorhome, or repairs to any covered defect(s), which you believe substantially impairs the value, use or safety of your motorhome, have taken 20 or more days to complete, you must, to the extent permitted by law, notify Warrantor directly in writing of the failure to successfully repair the defect(s) so that Warrantor can become directly involved in exercising a final repair attempt for the purpose of performing a successful repair to the identified defect(s).

Minor adjustments, such as adjustments to the interior or exterior doors, drawers, latches by way of example and not by limitation will be performed by your selling dealer during the first ninety (90) days of warranty coverage. Thereafter, such adjustments are the owner's exclusive responsibility as normal maintenance.

HOW TO GET SERVICE:

The "Acknowledgement of Receipt of Warranty/Product Information" form must be returned to Warrantor promptly upon purchase to assure proper part replacement and repair of your motorhome. Failure to return the "Acknowledgement of Receipt of Warranty/Product Information" form will not affect your rights under the Limited Warranty so long as you can furnish proof of purchase. For warranty service simply contact one of Warrantor's authorized service centers for an appointment, then deliver your motorhome (at your expense) to the service center.

If you need assistance in locating an authorized warranty service facility, contact Warrantor's Warranty Department (877-855-2867). The mailing address is:

P.O. Box 1486
Elkhart, Indiana 46515-1486

WHAT THE WARRANTY DOES NOT COVER:

This Limited Warranty does not cover: any motorhome used for rental purposes and any motorhome sold or registered outside of the United States or Canada; items which are added or changed after the motorhome leaves Warrantor's possession; items that are working as designed but with which you are unhappy with because of the design; normal wear and usage, such as fading or discoloration of fabrics, or the effects of moisture inside the motorhome; defacing, scratching, dents and chips on any surface or fabric of the motorhome, not caused by Warrantor; owner maintenance, including by way of example replacement of wiper blades, bulbs, filters, wheel alignments and resealing exterior sealant areas (see Care and Maintenance Section of Owner's Manual); the automotive chassis and power train, including, by way of example the engine, drive-train, steering, ride and handling, braking, wheel balance, muffler, tire wear or failure, tubes, batteries and gauges; appliances and components covered by their own manufacturer's warranty including, by way of example the microwave, refrigerator, ice maker, stove, oven, generator, roof air conditioners, hydraulic jacks, VCR, television(s), water heater, furnace, stereo, radio, compact disc player, washer, dryer, inverter and cellular phone; or flaking, peeling and chips or other defects or damage in or to the exterior or finish caused by rocks or other road hazards, the environment including chemical off-gassing, airborne pollutants, salt, tree sap and hail causing any damage including but not limited to corrosion. Component part and appliance manufacturers issue limited warranties covering those portions of the motorhome not covered by the Limited Warranty issued by Warrantor. To learn more on what specific component parts and appliances are excluded from the Limited Warranty issued by Warrantor please contact

Warranty

your selling dealership or Warrantor directly or review the warranty packet inside the Motorhome.

EVENTS DISCHARGING WARRANTOR FROM OBLIGATION UNDER WARRANTY:

Misuse or neglect, accidents, unauthorized alteration, failure to provide reasonable and necessary maintenance (see Owner's Manual), damage caused by off road use, collision, fire, theft, vandalism, explosions, overloading in excess of rated capacities, and odometer tampering shall discharge Warrantor from any express or implied warranty obligation to repair any resulting defect.

DISCLAIMER OF CONSEQUENTIAL AND INCIDENTAL DAMAGES:

THE ORIGINAL PURCHASER OF THE MOTORHOME AND ANY PERSON TO WHOM THE MOTORHOME IS TRANSFERRED, AND ANY PERSON WHO IS AN INTENDED OR UNINTENDED USER OR BENEFICIARY OF THE MOTORHOME, SHALL NOT BE ENTITLED TO RECOVER FROM WARRANTOR ANY CONSEQUENTIAL OR INCIDENTAL DAMAGES RESULTING FROM ANY DEFECT IN THE MOTORHOME, INCLUDING BY WAY OF EXAMPLE FUEL AND TRANSPORTATION EXPENSES TO DELIVER THE PRODUCT TO THE SERVICING DEALER, HOTEL ROOMS, LOST WAGES AND MOISTURE DAMAGE SUCH AS MOLD AND MILDEW. THE EXCLUSION OF CONSEQUENTIAL AND INCIDENTAL DAMAGES SHALL BE DEEMED INDEPENDENT OF, AND SHALL SURVIVE, ANY FAILURE OF THE ESSENTIAL PURPOSE OF ANY LIMITED REMEDY. Some states do not allow the exclusion or limitation of consequential or incidental damages, so the above exclusions may not apply to you.

LEGAL REMEDIES:

THIS LIMITED WARRANTY DOES NOT "EXTEND TO FUTURE PERFORMANCE". ANY ACTION TO ENFORCE THIS LIMITED WARRANTY OR ANY IMPLIED WARRANTIES SHALL NOT BE COMMENCED MORE THAN 90 DAYS AFTER THE EXPIRATION OF THE WARRANTY COVERAGE PERIOD DESIGNATED ABOVE. IF YOUR MOTORHOME IS NOT OF THE CURRENT OR PRIOR MODEL YEAR WHEN YOU TAKE DELIVERY OF THE MOTORHOME OR YOU USE YOUR MOTORHOME FOR COMMERCIAL OR BUSINESS PURPOSES OTHER THAN FOR RENTAL PURPOSES, ANY ACTION TO ENFORCE THIS LIMITED WARRANTY OR ANY IMPLIED WARRANTIES SHALL NOT BE COMMENCED MORE THAN ONE YEAR AFTER THE EXPIRATION OF THE WARRANTY COVERAGE PERIOD DESIGNATED ABOVE. UNLESS PROHIBITED BY STATE LAW, THE PERFORMANCE OF REPAIRS SHALL NOT SUSPEND THIS LIMITATIONS PERIOD FROM EXPIRING AND ANY LEGAL ACTION TO ENFORCE WARRANTY RIGHTS AGAINST WARRANTOR MUST BE BROUGHT WITHIN THE STATE OF INDIANA. Some states do not allow the reduction in the statute of limitations, so the above reduction in the statute of limitations may not apply to you.

Warrantor participates in the Consumer Arbitration Program for Recreational Vehicles (CAP-RV) operated by DeMars & Associates. The CAP-RV program operates as a certified mechanism under the review of the California Arbitration Certification Program. You must utilize the arbitration program before claiming rights conferred by 15 USC section 2310 (Uniform Commercial Code) or Civil Code section 1793.22(b) (Tanner Act). You are not required to use the program if you choose to seek redress by pursuing rights and remedies not created by those laws. To find out more about the program or to request an application/brochure please call the Arbitration Administrator Office toll free (800) 279-5343. Members of the Armed Forces who purchased the vehicle in California, or who were stationed in or a resident of California at the time of purchase (regardless of state of purchase) or who are stationed in California at the time of application to this program, may utilize the CAP-RV program.

THIS WARRANTY GIVES YOU SPECIFIC LEGAL RIGHTS. YOU MAY ALSO HAVE OTHER RIGHTS, WHICH VARY FROM STATE TO STATE.

Julian Date: 04/29/13

Thor Motor Coach reserves the right to make changes in Vehicles built and/or sold by it at any time without incurring any obligations to make the same or similar changes on Vehicles previously built and/or sold by Thor Motor Coach.

As the proud owner of a Thor Motor Coach, you want to trust that your unit will continue to perform at its peak. To ensure this Thor Motor Coach has provided you this checklist of the responsibilities of the Thor Motor Coach owner. Please make sure that this list is carefully observed and adhered to in order to maintain your Limited Warranty.

Please refer to the Maintenance Schedule to determine when your inspections should take place.

Check both house batteries and chassis battery and tighten connections if necessary. Clean the terminals if necessary. Check to make sure that the batteries have the proper water levels in them, and fill if necessary. Check the charge and recharge if necessary. Keep connections clean and covered with a light coat of grease.

There is a certain danger involved when working with batteries. If you are unfamiliar with these dangers, contact a Thor Motor Coach dealer.



Just as in your home, it is the owner's responsibility to periodically check the batteries in the smoke detector, propane detector and carbon monoxide detector when applicable. We recommend that you change the batteries every six months to ensure proper working order.

The owner is responsible for checking to ensure that the vehicle has as little condensation in it as possible. The condensation in a motorhome is much greater than in most houses because the insulated walls of the vehicle are much thinner than house walls, and the small size and tight construction of the vehicle allow a quick buildup of high moisture levels in the inside air.

This can be reduced by always keeping the bathroom door closed and the window or vents open when bathing, and for a period of time when you have finished bathing or cooking, to allow for dissipation of all the moisture. Use your vent hood and fan when cooking. Don't hang wet clothes in your unit to dry. When left for prolonged periods of time, condensation can cause considerable damage to your vehicle.

Most exterior parts of your motorhome are made of fiberglass, which is a very durable material, but not indestructible. Exposure to the elements can cause premature deterioration without routine maintenance, especially in hotter climates. The effects may be; fading, yellowing, or chalking, however these are surface cosmetic changes, which do not affect the strength of your unit. Simple maintenance through cleaning by washing and waxing will ensure lasting beauty.

The same fading may occur to carpeting and upholstery. Be sure to keep your shades down in extremely sunny locations and maintain proper cleaning techniques for both carpet and upholstery.

The front suspension and steering system of this vehicle was factory aligned using highly accurate equipment prior to delivery to the dealership. We recommend that the alignment is checked after you have fully loaded the motorhome according to your personal needs. If necessary, adjust alignment for the loaded motorhome. Thereafter, the alignment should be inspected yearly to help prevent uneven tire wear.

Sanitize the fresh water system at least once per year or whenever the motorhome is unused for prolonged periods of time. This will help keep your water system fresh and discourage the growth of bacteria that can contaminate the water supply. Make sure that the tanks are properly treated with the right chemicals for disinfection.

PRODUCTION CHANGES

OWNER RESPONSIBILITY CHECKLIST

Batteries

Battery Replacement

Condensation

Exterior/Interior

Alignment

Potable Tank

Warranty

Proper Load Balance	Your motorhome is built to withstand a certain maximum load. Check the amount listed on the Federal Certification Label in the driver's area of your motorhome to determine safe load limits. NEVER OVERLOAD THE MOTORHOME. Reference pages 21, 23 and 24 for proper loading and weight distribution.
Sealants	Weatherproofing sealants are used around the doors, windows, vents, and joints during construction of your motorhome. These sealants are subject to deterioration from exposure, and must be checked periodically to assure the weatherproof integrity of your unit. If evidence of cracking or voids in the sealants is apparent, have your dealer reseal these areas. Proper sealant coverage should be checked and resealed at least once every six months. Please see Chapter 10 - "Care and Maintenance" for instructions on properly sealing the roof area. Failure or neglect of proper sealant maintenance could result in leakage, and may reduce or void your warranty protection.
Service Calls	It is important that the owner realize that Thor Motor Coach's Limited Warranty covers warrantable repairs that are performed by an authorized Thor Motor Coach dealer at their service center or facility only. If you are unable to bring your unit in for repairs, Thor Motor Coach is not responsible for the cost of the actual service call charged to come out to your unit.
Slideout Lubrication	If your slide-out system becomes squeaky or makes any noises while operating, it is permissible to apply a coat of lightweight oil to the drive shaft and roller areas located below the main floor. Remove any excess oil so dirt and debris cannot build up.
Step Lubrication	To maintain the integrity of the retractable step in your motorhome, you must periodically inspect it for rust or damage, also see that it is lubricated to function safely and to ensure proper working order.
Tire Pressure	The owner is responsible for maintaining proper tire pressure in the vehicle's tires. Check the tire specifications on the Federal Certification Label located in the driver's area for the proper pressure. You will ensure optimum driving standards by keeping your vehicle maintained.
Travel Bars	Never forget to remove your travel bars from your slide-out prior to opening. Failure to do so could result in severe damage to yourself and/or your motorhome, which will not be covered under the Limited Warranty.
Windshields	Like most cars, your motorhome's windshield is not covered under the Limited Warranty. Items such as cracks, stone chips and holes are regarded as normal wear and tear, and will not be considered as a manufacturing defect.
Winterization	Please make sure that your vehicle is properly winterized before long periods of storage. To find a complete listing of the winterization procedures, refer to this manual's section called "Winterization Procedures". Failure to properly winterize your vehicle may result in damage to your motorhome which would not be covered under the Limited Warranty.

SUPPLIERS PROVIDING SEPARATE WARRANTIES

The following list of components has been compiled to help you know which products on your motor home may have their own warranties. If you have any of these components on your motor home, be sure to check the literature supplied by the manufacturer to see if they require that you register your purchase with them to validate their warranty. We recommend that you send the various warranty registration cards immediately before any time constraints on registration expire. Manufacturer's literature is contained in a separate packet furnished with the owner's manual on newly delivered units. Only those products and options which are on your motor home will be included in this packet. You should go over this literature with your dealer during the pre-delivery inspection. Any shortages of literature should be reported to the dealer at that time

Appliances

Air Conditioner (Roof)
Awnings
Back-up Monitor
Central Vacuum
DVD Player
Fireplace
Furnace
Home Theater System
Ice Maker
Microwave
Radios
Range and Cooktop

Refrigerator

Roof Vents

Water & Drainage

Toilet
Washer/Dryer Combo
Water Faucets
Water Filter
Water Heater
Water Pump

Chassis

Air Conditioner
Batteries
Cruise Control

Leveling Jacks

Propane

Propane Gas Tank
Regulator

Electrical

Battery
Converter
Electrical Entry Step
Generator
GFCI Receptes
Inverter
Propane Gas Leak Detector

Allison Transmission

800-524-2303
www.allisontransmission.com

ASA Electronics

800-688-3135
www.asaelectronics.com

Atwood Mobile Products, Inc.

800-825-4328
www.atwoodmobile.com

Caterpillar

877-777-3126
www.cat.com

Cobra Electronics Corp.

773-889-3087
www.cobra.com

Cummins

800-343-7357
www.mantank.com

Dometic

800-544-4881
www.dometicusa.com

Evans Tempcon

800-878-7147
www.evanstempcon.com

Fantastic Vent

800-521-0298
www.fantasticvent.com

First Alert

800-323-9005
www.firstalert.com

Flair Interiors

574-534-2163
www.flairinteriors.com

Flexsteel Industries

574-831-4050
www.flexsteel.com

Ford

800-392-3673
www.Ford.com

Freightliner

800-385-4357
www.freightlinerchassis.com

GM

800-353-3867
www.gmfleet.com

Good Year

800-321-2136
www.goodyear.com

Hehr International, Inc.

574-935-5122
www.hehr-international.com

HWH Corporation

800-494-3213
www.hwhcorp.com

Intellitec

800-251-2408
www.intellitec.com

KIB Enterprises

800-250-7051
www.kibenterprises.com

KVH Industries, Inc.

401-847-3327
www.kvh.com

Kwikee Products Co. Inc.

800-736-9961
www.kwikee.com

Lippert Components

574-534-0001
www.lci1.com.com

Magnum Energy

425-353-8833
www.magnumenergy.com

Manchester Tank

800-877-8265
www.mantank.com

Michelin

800-847-3435
www.michelin.com

Mor/ryde

574-293-1581
www.morryde.com

MTI Industries, Inc.

800-383-0269
www.mtiindustries.com

Norcold

800-543-1219
www.norcold.com

Onan

800-888-6626
www.onan.com

Scope Technologies

574-295-0229
www.scopetechnologies.com

Select Comfort

888-580-9237
www.selectcomfort.com

Sharp

800-237-4277
www.sharpusa.com

SHURflo, LLC

800-854-3218
www.shurflo.com

Splendide

800-356-0766
www.splendide.com

TDI Products

866-713-1489
www.tdiproducts.com

Thetford

800-521-3032
www.thetford.com

Thor Motor Coach Inc.

(877)855-2867
www.thormotorcoach.com

TriMark Corp.

800-431-8616
www.trimarkcorp.com

Velvac

800-783-8871
www.velvac.com

Viracon

800-533-0482
www.viracon-autoglass.com

Visteon Corp.

800-847-8366
www.visteon.com

Winegard Co.

800-288-8094
www.winegard.com

Workhorse

800-877-294-6773
www.workhorse.com

Planning and Preparation

A thorough working knowledge of your motorhome is important if you are going to get the most out of the convenience and safety items built into your unit. Be as familiar with it as you are with your personal car or truck. Study all the booklets included in your Owner's Information Kit. These booklets cover details of operation for the major appliances and equipment built into your motorhome for your comfort, convenience and safety. Your selling dealer should provide you with a complete walk through of your vehicle at the time of purchase. Any questions and concerns should be addressed at that time.

The vehicle licensing laws vary from state-to-state. Check with your state license bureau or nearest branch office for the requirements of your state. Be sure to renew your license if it has expired or will expire during your trip. Your motorhome is considerably larger and heavier than your car, therefore certain precautions should be exercised. A CDL license may not be required to operate your motorhome, but Thor Motor Coach recommends you attend a CDL class to better understand the motorhomes driving and handling characteristics. Thor Motor Coach wants your driving experience to be pleasant and enjoyable.

Talk to your insurance agent about the appropriate coverage for your motorhome. Always carry your policy card.

Follow a consistent schedule of inspection and maintenance for your motorhome. Your continuing safety and comfort depend on it. This manual includes recommended maintenance intervals and instructions. Adherence to these schedules will minimize the possibility of failure of any important system or part of your motorhome. The time spent inspecting and maintaining your motorhome will provide you with many years of recreational pleasure. Improper inspections or maintenance neglect may invalidate your Limited Warranty.

Proper loading is one of the most important considerations when traveling in a motorhome. Your motorhome is built to withstand a certain maximum load. Check the Federal Certification Label located in the driver's area to determine the safe load limits. For safety's sake, NEVER OVERLOAD THE MOTORHOME. This chapter contains information about proper loading and weighing of your motorhome.

Know how to control your motorhome on the highway. Be familiar with passing and stopping requirements, and problems that can develop. Know how to brake properly, how to back up and how to turn. Practice in a secluded place until you become familiar with the handling characteristics and techniques of your motorhome. Don't overlook the laws of your state that govern driving a motorhome. Your state Motor Vehicle Department office can provide you with the applicable vehicle codes that spell out your rights and responsibilities as a motorhome owner.

Whenever you depart, be it from your home, rest area, or campsite. You should perform these pre-travel checks:

Should be inspected before each trip for uneven wear, road damage, foreign objects, peeling or bulging, and correct tire pressure. Heat generated by surface friction will increase the tire's air pressure, therefore do not bleed air out of a hot tire. Check tire pressure after the vehicle has been parked for at least one hour. Inflate tires to recommended pressure as indicated on the Federal Certification Label located above the Drivers area.

Proper tire inflation is extremely important.

⚠ CAUTION

When purchasing a new tire, be certain it is the same size and has the same ply rating and load range as the original tire. DO NOT mix radial ply with bias or bias-belted tires.

⚠ CAUTION

READ THE BOOK

LICENSES

INSURANCE

INSPECT AND MAINTAIN

LOADING AND WEIGHT DISTRIBUTION

CONTROL OF THE MOTORHOME

PRE-TRAVEL CHECK Tires

Planning and Preparation

Wheel Lugs	Must be tightened to the specifications in the Chassis Manufacturer's Owner's Manual.
Windshield	Should be clean, wiper blades inspected, and windshield washer reservoir filled.
Lights	Should be tested, including brake lights, warning flashers, clearance lights, tail lights, turn signals and headlights. Clean all lens covers.
Rearview Mirror	Should be adjusted so the driver can see to the rear on both the right and left side of the unit.
Power Cord	(120 Volt shoreline) must be unplugged from the external source and properly stored for transit, also making sure the cord hatch is secured.
Water Fill	Hoses must be disconnected, properly drained and stored, and the caps and hatches secured. Fill the fresh water tank as required prior to storing hoses.
Sewage	Should be emptied from the holding tanks before traveling. Termination valves must be closed and locked. The sewer hose must be removed from the termination valve outlet and stored. Termination cap must be securely fastened to the termination outlet.
Entry Step	Must be returned to its travel position. Pay special attention to this every time you move your unit. Severe damage may result if not retracted during transit.
Propane Tank	Levels at the monitor panel should be checked, and gas line connections should be checked for leaks.  Note: Some states prohibit vehicles equipped with propane tanks from using tunnels. A few other states prohibit traveling with the service valve open and the pilot lights lit. Check the regulation of the states through which you intend to travel.
Doors And Drawers	Should be closed and secured. Loose items should be secured or stored away. ⚠ CAUTION Be sure all loose items are secured or properly stored while the vehicle is in motion. Possible overlooked items may include canned goods, small appliances (on countertop), cooking pans (on range), or free standing furniture. These items could become dangerous projectiles during a sudden stop.
Compartment Doors	Storage and equipment should be closed and locked, also making sure that loose items are secured or stored for transit.
Refrigerator Door	Door should be secured with the travel latch, and the items inside made ready for transit.
Windows And Vents	Should be closed and secured or adjusted as desired.
OPENING CHECKLIST	If the motorhome was properly and carefully prepared for storage, taking it out of storage will not be difficult. The following checklist assumes that you stored your RV with care. If you didn't, and extensive freeze damage or other serious deterioration has occurred, consult your dealer or an authorized service center for advice. <ul style="list-style-type: none">• Thoroughly inspect the outside of your RV. Look for animal's nests in wheel wells, in engine, air cleaner, or in other out of the way places. Clean all appliance exhaust vents, ceiling vents and air conditioning covers.

- Changing the wiper blades on your motorhome is similar to your car. Remove the screw, take off the old blade, and replace with a similar style and length blade. Lubricating pivot points with thin lubricating oil is also recommended.
- Check that all furnace, water heater and refrigerator openings are free of debris, insect nests, webs, etc.
- Open all doors and compartments. Check for animal or insect intrusion, water damage, or other deterioration.
- Check charge level in batteries. Refill with distilled water and recharge if necessary. Reinstall batteries if necessary. Be sure cable ends and terminals are clean and free of corrosion. Turn the Battery Disconnect Switch off if applicable.
- Check tire pressure. Inflate to the specified cold pressure.
- Remove coverings from windows if necessary.
- Open vents and windows for ventilation.
- Drain, flush and sanitize the fresh water system. Inspect drain lines for leaks. Replace if necessary. Do not try to repair, as this is usually ineffective.
- Install a new water filter (if your unit is equipped with this).
- Operate all faucets and fixtures in the fresh water system. Check for leaks at all joints and fittings. Repair if necessary.
- Check 12 Volt circuit breakers and inspect all fuses.
- Operate all 12 Volt lights and accessories.
- Install new batteries in battery operated devices.
- Test propane, smoke and carbon monoxide detectors. Replace the batteries if necessary.
- Check the monitor panel operation.
- Open and operate all vents and vent fans. Remove any outside coverings if applicable.
- Inspect 120 Volt electrical system which includes power cord, converter, all outlets and exposed wiring. If defects are found, consult your servicing dealer or an authorized service center.
- Operate 120 Volt appliances and air conditioner (s). Be sure to uncover air conditioner shroud(s).
- Inspect the propane system and check for leaks. If propane tank shows signs of rust or corrosion, have it inspected by a qualified propane technician. Refill if necessary.
- Operate each propane appliance. Observe all burner/pilot flames for proper color and size.
- If necessary, have propane regulator adjusted for proper pressure by a qualified technician.

- Check sealants around all roof and body seams and windows. Reseal if necessary.
- Lubricate all exterior locks, hinges, and latches.
- Wash and wax exterior. Inspect body for scratches or other damage. Touch up or repair as necessary. Flush underside of the motorhome thoroughly.
- Check all the chassis fluid levels including engine oil, coolant, power steering fluid, brake fluid, transmission, rear axle oil and washer fluid. Top off if necessary.
- Check all exterior lights; clearance, brake, turn, and reverse should be fully functional.

Your motorhome should be ready for a new traveling season. Your dealer can check your preparation and correct any defects or make any necessary adjustments.

These items are the absolute minimum requirements necessary for pre-travel.

WEIGHTS

Your motor home is designed to carry the loads defined by the Gross Axle Weight Rating (GAWR - the value specified by the chassis manufacturer as the load carrying capacity of a single axle system, as measured at the tire/ground interface.) The Gross Vehicle Weight Rating (GVWR - the maximum permissible loaded weight of the motor home) is shown on the vehicle information sticker posted near the driver's side front window or inside the driver's side door jam. These ratings are for a fully loaded vehicle including passengers and normal belongings

⚠ WARNING **EXCEEDING THE GAWR OR GVWR OF YOUR MOTOR HOME CAN CAUSE UNDESIRABLE HANDLING CHARACTERISTICS and may even create a safety hazard. Modification of your vehicle to carry additional equipment or vehicles is not recommended and may void your warranty.**



Note: Be sure the weight of passengers, equipment and supplies does not cause your motor home to exceed axle loads and overall vehicle loads for which it was designed. If in doubt, weigh the vehicle at a public scale. Keep in mind the number of safety belts in a unit are there for the convenience and use of the owner. Carrying the number of people equal to the number of seat belts may exceed the weight ratings. A motor home has the potential to be overloaded and removal or redistribution of weight may be necessary from time to time to stay within weight ratings. Your motor home includes a "Weight Information Label." This label provides specific weight information for your motor home as a guideline so that you can determine the load carrying capabilities.

Federal Weight Label

The Thor Motor Coach Motor Home WEIGHT SPECIFICATIONS yellow label concisely states the occupant and cargo carrying capacity of your motor home (per the requirements of 49 CFR part 571.120 as issued by the National Highway Traffic Safety Administration - NHTSA).

Capacity

The yellow MOTOR HOME OCCUPANT AND CARGO CARRYING CAPACITY weight label is affixed to the interior side of the forward-most door of your motor home on the passenger side This label indicated how much weight you can safely carry within the vehicle and is affixed to the entrance door, directly below the window screen for Class A units and on the front door jamb for Class C units.

The total weight of passengers, cargo, trailer tongue weight, and water should never exceed the value shown on the label.

A typical example of this label is shown below for reference purposes only. The numbers shown on this page may not be applicable to your vehicle. Please reference the Yellow label affixed directly to the door of your motor home for your actual Occupant and Cargo Carrying Capacity:

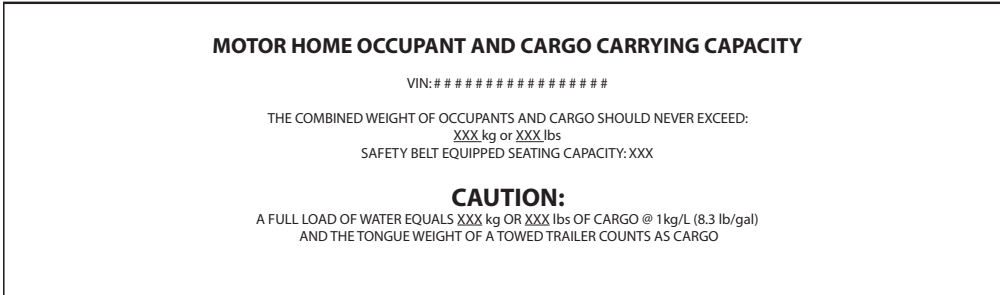

Note: DO NOT OVERLOAD THE MOTOR HOME

When loading your cargo, be sure it is distributed evenly to prevent overloading front to back and side to side. Heavy items should be placed low and as close to the axle positions as reasonable. Too many items on one side may overload a tire.

Periodically weigh the motor home at a public scale to determine axle loads. The following procedure is suggested, although any method recommended by the scale operator which correctly determines weight value is acceptable. During all measurements, it is important to keep the vehicle as level as possible.

To weigh your motor home correctly, measure the fully loaded vehicle axle by axle and wheel position by wheel position. You can find several certified public or commercial scales at moving and storage lots, farm suppliers with grain elevators, gravel pits, recycling companies and large commercial truck stops. You can also look in the telephone book under “weighers” or “weighing”. Allow adequate time, since the entire weighing process can take up to 30 minutes. There may be a small fee for each weight taken, but the expense is a worth while investment toward the safe and economical operation of your motor home.

Your motor home must be weighed fully loaded. That is with passengers, food, clothing, fuel, water, propane, supplies etc. Any towed vehicle (car/pickup, boat, or trailer) or item loaded on brackets on the back of the motor home should also be included in the weighing.

1. The following steps are suggested when using a long platform scale:
 - a. Pull onto the scale so that only the front axle is on the platform with the end of the scale midway between the front and rear axles and record the scaled weight.
 - b. Pull forward until the full unit is on the scale and record the weight.
 - c. Pull forward so that only the rear axle is on the scale and record the weight.

WEIGHING YOUR LOADED MOTORHOME

Where To Weigh Your Motorhome

How To Weigh Your Motorhome



Reading a



Reading b



Reading c



Note: Even though the weight of the total axle may be within the axle's rating, it may be overloaded on one side. This causes one wheel position to be overloaded. Therefore, side-to-side weighing should be done.

To obtain the individual wheel position weights, repeat this process with only one side of the motor home on the scale. To determine individual wheel position weights, it is necessary to repeat the previous three steps (1a, 1b, and 1c), but this time, use only one side of the scale. To calculate the opposite side of the vehicle wheel position weight, subtract this side's weights from the weights recorded in steps 1a, 1b, and 1c.

Your motor home must remain as level as possible on the scale, even though an axle or side is not physically on the scale. To obtain the side-to-side weights, there must be enough space on either side of the scale to allow the motor home to be partially off the scale.

Individual wheel position weights must not exceed the maximum tire load capacity.



CAUTION Maximum tire load capacity can only be achieved by utilizing the maximum allowable pressure (psi) as listed on the sidewall of the tire.



Note: The above information is provided by the Tire Industry Safety Council Rubber Manufacturer's Association. Used with permission. (http://www.rma.org/tire_safety/)

For improved accuracy, Thor Motor Coach recommends using a segmented 4-pad scale, when possible, to determine individual wheel weights. The corner weights should not exceed half of the respective Gross Axle Weight Rating (GAWR) or the maximum load rating for the tire or set of dual tires at the rear, whichever is less. The maximum load rating for the tire can be found embossed on the tire's sidewall. If any of the corner weights exceed half of the listed GAWR or tire ratings, relocate the passengers and redistribute or remove a portion of the cargo until the weight is within the proper limits for all four corners of the vehicle.



Note: Additional cargo carrying capacity can be obtained by reducing the amount of fresh water carried while driving.

Check vehicle weight periodically to obtain optimum mileage from tires and improve handling. Tires should always be inflated as recommended in the chassis manufacturer's instructions or on the tire sidewall. See your chassis operator's manual.

Weight Distribution

Improper weight distribution or too much weight on your motorhome's suspension system can cause spring, shock absorber, or brake failure, handling or steering problems, irregular tire wear, tire failure or other damage.

An overloaded motor home is hard to drive and hard to stop. In cases of serious overloading, brakes can fail completely, particularly on steep hills. The load a tire will carry safely is a combination of the size of tire, its load range, and corresponding inflation pressure.

The following is an explanation of commonly used weight abbreviations:

- Gross Vehicle Weight Rating (GVWR) is the maximum permissible weight of this motor home.
- Unloaded Vehicle Weight (UVW) is the weight of this motor home as manufactured at the factory with full fuel, engine oil, and coolants.
- Occupant and Cargo Carrying Capacity (OCCC) is equal to the GVWR minus UVW and LP. In other words, OCCC is how much weight in occupants, cargo, water and trailer tongue weight that can be added to the motor home without exceeding the GVWR.
- Gross Combined Weight Rating (GCWR) means the maximum allowable loaded weight of this recreation vehicle with its towed trailer or towed vehicle.
- Gross Axle Weight Rating (GAWR) is the value specified as the load carrying capacity of a single axle system, as measured at the tire-ground interfaces.
- If a boat, trailer or other vehicle is being towed, it should be weighed and combined with the towing vehicle's weight to ensure the total weight does not exceed the GCWR.



Identification and Safety

It is advisable to contact the Department of Motor Vehicles in each respective state, for up-to-date information regarding operation and licensing requirements for your particular motor home.

LAWS OF THE ROAD

The state of California currently requires operators of motor homes over 40 feet in length to obtain a non-commercial class B license. California has also enacted legislation limiting use of motor homes in excess of 40 feet, to approved roadways. You may contact Caltrans at www.dot.ca.gov or 916-654-5741 for current information regarding these California statutes.

The motor home serial number label is mounted on the inside wall next to the driver's seat on a Class A motor home and on the inside of the driver's door post on a Mini motor home. Refer to the chassis owner's manual for the location of the chassis vehicle identification number on all motorized motor homes.



Note: Always give model, year, and the V.I.N. number information when ordering parts. Also, we recommend that you keep a copy of this information separate from the motor home in the event theft or vandalism requires you to supply a copy to the authorities.

Decals and data plates used throughout the motor home aid in its safe and efficient operation; others give service instructions. Read all decals, data, and instruction plates before operating your motor home.



Note: When any decal, data, or instruction plate is damaged, painted over, removed, etc.; the item should be replaced immediately.

The following warnings are posted throughout the motor home to provide information on Propane safety. They have been installed not only because of the requirement to do so, but also as a constant reminder to occupants of the motor home to exercise proper caution when using or being around Propane appliances and equipment. We are listing them here so you may study them and make sure that you and your family understand and follow them.

IT IS NOT SAFE TO USE COOKING APPLIANCES FOR COMFORT HEATING. COOKING APPLIANCES NEED FRESH AIR FOR SAFE OPERATION.



TO ENSURE PROPER VENTILATION BEFORE OPERATING A PROPANE APPLIANCES YOU SHOULD OPEN OVERHEAD VENTS, TURN ON THE EXHAUST FAN, AND OPEN A WINDOW.



Warning labels are located in the cooking area to remind you to provide an adequate supply of fresh air for combustion. Unlike homes, the oxygen supply is limited due to the size of the motor home, and proper ventilation when using the cooking appliances will avoid dangers of asphyxiation.

Identification and Safety

FIRE SAFETY

Fire safety is an important part of owning a motor home. Make sure that everyone traveling in the motor home is familiar with the location of exits, including emergency exit windows should an emergency arise. The following basic rules of fire prevention can help eliminate the possibility of a fire:

- Never store flammable liquids within the motor home.
- Keep cooking surfaces clean.
- Never clean with a flammable liquid.
- Never leave cooking food unattended.
- Never smoke in bed, and always use an ashtray.
- Never allow children to play with Propane gas or electrical equipment.
- Never use an open flame as a flashlight.
- Always repair faulty or damaged wiring and electrical components.
- Never overload electrical circuits.
- Locate and repair Propane gas leaks immediately.
- Don't allow rubbish to accumulate.
- Spray fabrics annually with a flame retardant.

If a fire does start, make sure to follow these basic rules of safety:

1. Have everyone evacuate the motor home as quickly as possible.
2. After everyone is clear, check the fire to see if you can attempt to put it out. If it is too large, or the fire is fuel fed, get clear of the motor home and have the fire department handle the emergency.
3. **DO NOT** attempt to use water to put out the fire. Water can spread some types of fire, and electrocution is possible with an electrical fire.



WARNING DO NOT STORE PROPANE CONTAINERS INSIDE THE MOTOR HOME. Propane containers are equipped with safety devices which relieve excessive pressure by discharging gas to the atmosphere. Failure to comply could result in explosion resulting in death or serious injury.



WARNING Portable fuel burning equipment including wood or charcoal burning grills and stoves should not be used inside the motor home because they may cause fire or asphyxiation.

FIRE EXTINGUISHER

Underwriter Laboratories classify fires into three types:

Class A: Fires in wood, paper, fabric, rubber, and certain plastics

Class B: Flammable liquids such as grease, cooking oils, gasoline, or kerosene

Class C: Electrical fires started from live electrical wires, from short circuits, motors, or switches

The fire extinguisher, which is located by the entry door of the motor home, is a chemical type suitable for extinguishing small fires of the class B or C type. Extinguishers are designed to put out fires in the initial stage, not when it is blazing out of control. If a fire cannot be approached within 10', the extinguisher will not be effective.

To fight a fire with an extinguisher, first remove the tamper tape which covers the discharge push button. Hold it upright and stand six to ten feet from the fire with a clear path to an exit. Press the button down all the way, aimed at the base of the fire and spray with quick motions from side to side.

Avoid inhaling the dry chemicals. Although non-toxic, they could cause temporary irritation and vomiting. When the fire is out, clean up the area as soon as possible. The dry chemicals are non-corrosive, but some residue may cause surface damage if left too long.

To keep the fire extinguisher in proper operating conditions:

1. **Check Pressure** monthly or more often. Check the nozzle for obstruction. Press the green pin below the nozzle. If it returns and sticks out from the extinguisher, it is operable. If the pin does not come back, discard extinguisher. Refillable models have a pressure gauge to check.
2. Check the **Tamper Tape** to make sure it is intact. DO NOT test the extinguisher. Even a partial discharge may cause leakage.
3. When checking the extinguisher for pressure, enter the date checked on the **Inspection Tag** furnished with the motor home. Regular inspections will help insure the condition.
4. **Agitate Dry Chemical** every six (6) months by inverting the bottle and lightly shaking for several seconds. This will help prevent the dry chemical from settling due to in motion vibrations.

BOTH THE SMOKE ALARM AND THE CARBON MONOXIDE ALARM CANNOT OPERATE WITHOUT A 9 VOLT BATTERY. Removing the battery for any reason, or failing to replace the battery at the end of it's service life, removes your protection. Refer to the manufacturers owner's manual for proper replacement batteries.



CARBON MONOXIDE AND SMOKE DETECTORS

Test smoke detector operation after vehicle has been in storage, before each trip, and at least once per week during use. Replace battery every six months.



The motorhome should never be operated or occupied unless the smoke detector is present and functioning properly.



The smoke alarm will only indicate the presence of smoke that reaches the sensor. The smoke alarm is not designed to sense gas, heat or flames.

The CO alarm is not designed to detect fire or any other gas. It will only indicate the presence of CO gas at the sensor. CO may be present in other areas.

For instruction on programming the alarm refer to the Smoke Alarm User's Manual within your Owner's Packet for detailed setup information.

Never remove a fuse or battery providing power to a carbon Monoxide, LP, or Smoke alarm for the purpose of turning the alarm off.



Identification and Safety

Testing Procedure

⚠ WARNING DO NOT STAND CLOSE TO THE ALARM WHEN THE HORN IS SOUNDING. Exposure at close range may be harmful to your hearing. When testing, step away when the horn starts sounding.

⚠ WARNING NEVER USE AN OPEN FLAME OF ANY KIND TO TEST THIS UNIT. The built-in test switch accurately tests the unit's operation as required by Underwriters Laboratories, Inc. (UL).

It is important to test this unit every week to make sure it is working properly. Using the test button is the recommended way to test this Smoke Alarm. Press and hold the test button on the cover of the unit until the alarm sounds (the unit may continue to alarm for a few seconds after you release the button). If it does not alarm, make sure the unit is receiving power and test it again. If it still does not alarm, replace it immediately. During testing you will hear a loud, repeating horn pattern: 3 beeps, pause, 3 beeps, pause; and the Red LED will flash rapidly.



Note: If the unit does not alarm, make sure the batteries are correctly installed and test again. If the unit still does not alarm, replace it immediately.

Regular Maintenance

This unit has been designed to be as maintenance free as possible, but there are a few simple things you must do to keep it working properly. Use only the replacement batteries listed below. The unit may not operate properly with other batteries. Never use rechargeable batteries since they may not provide a constant charge.

- Test it at least once a week.
- Clean the Smoke Alarm at least once a month; gently vacuum the outside of the Smoke Alarm using your house hold vacuum's soft brush attachment. Test the Smoke Alarm. Never use water, cleaners or solvents since they may damage the unit.
- If the Smoke Alarm becomes contaminated by excessive dirt, dust and/or grime, and cannot be cleaned to avoid unwanted alarms, replace the unit immediately.
- Relocate the unit if it sounds frequent unwanted alarms. See product manual under "Locations to Avoid for Smoke Alarms" for details.
- When the battery becomes weak, the Smoke Alarm unit will "chirp" about once a minute. This low battery warning should last 7 days, but you should replace the battery immediately to continue your protection.



Note: If locking pin is engaged see "Locking Feature" section for unlocking instructions.

Choosing a Replacement Battery

Your Smoke Alarm requires one standard 9V battery. The following batteries are acceptable as replacements: Duracell #MN1604, (Ultra) #MX1604; Eveready (Energizer) #522. You may also use a Lithium battery like the Ultralife U9VL-J for longer service life between battery changes.

Carbon monoxide is a colorless, tasteless, odorless gas. It is a by-product of combustion in the engine, generator and propane appliances. The engines in your motorhome and generator system produce it constantly while they are running. CARBON MONOXIDE IS DEADLY. Please read and understand the following precautions to protect yourself and others from the effects of carbon monoxide poisoning.

DO NOT ALTER OR MODIFY ANY COMPONENT OF THE EXHAUST SYSTEM AT ANY TIME. Inspect the exhaust system at regular intervals for damage. If you suspect or locate damage to the system, have it repaired immediately by a qualified service facility.



NEVER SLEEP WHILE THE ENGINE OR GENERATOR IS RUNNING. Be aware of carbon monoxide poisoning and its symptoms: Dizziness, Severe Headache, Vomiting, Weakness, Sleepiness, Muscular Twitching, and Throbbing in Temples. If anyone in the motor home experiences any of these symptoms, shut off the engine, and immediately go outside into fresh air. Get medical attention as soon as possible.



Over-filling the Propane gas tank can result in uncontrolled gas flow which can cause fire or explosion. A properly filled tank will contain approximately 80% of its volume as liquid Propane. An 80% automatic shut-off valve is installed on the Propane gas tank which will automatically prevent further filling when the gas volume has reached 80% of tank capacity.

This tank is equipped with an automatic valve designed to close at 80% liquid full. Always open 20% fixed liquid level bleeder gauge while filling. Stop filling if liquid appears before valve shuts off.



ALL PROPANE GAS IS CONTAINED UNDER PRESSURE. DUE TO THE DANGEROUS POTENTIAL OF ANY COMPRESSED GAS, IT IS MANDATORY THAT THE FOLLOWING REQUIREMENTS FOR THE USE OF THIS TANK BE FOLLOWED: Tanks are to be installed, fueled and maintained in accordance with the state and local codes, rules, regulations or laws and in accordance with the NFPA Pamphlet 58, division IV.



Only personnel trained in the handling of Propane may fill, test or repair the Propane gas system.

IF YOU SMELL GAS, EXTINGUISH ANY OPEN FLAMES, PILOT LIGHTS, AND ALL SMOKING MATERIALS. DO NOT TOUCH ELECTRICAL SWITCHES. Shut off the gas supply at the tank valve(s) or gas supply connection. Open doors and other ventilation openings. Do not use the range hood. Leave the area until the odor clears and have the system checked by a trained professional before using again.



Propane gas regulators must always be installed with the diaphragm vent facing downward. Regulators that are not in compartments have been equipped with a protective cover. Make sure that the regulator vent faces downward and the cover is kept in place to minimize vent blockage which could result in excessive gas pressure causing fire or explosion.

CARBON MONOXIDE SAFETY PRECAUTIONS

LP SAFETY

Identification and Safety

PROPANE GAS DETECTOR

The propane gas detector is powered at all times when the coach battery disconnect switch is in the ON position. When power is supplied to the detector the green indicator light will illuminate. After 60 seconds, the detector will begin monitoring the air in the motor home for combustible vapors. The Propane you use to cook, refrigerate, and heat is combustible. Should a leak occur, the detector will produce a pulsating alert sound when the gas reaches the detector. This alert will continue to sound until the gas has dissipated or until the reset button is pressed. When the alert sounds, open all doors and major windows to air out the motor home and turn the gas off at the tank. Do not reenter the motor home until the alert stops sounding. If the alert sounds a second time after the gas is turned back on, leave the gas off and have a qualified Propane Dealer or Motor Home Service Center make the necessary repairs. The reset button only stops the alert from sounding for 60 seconds. This device is intended for detection of carbon monoxide and propane gas ONLY.

Detector Maintenance



Note: Never use water, cleaners or solvents to clean the detector.

The following maintenance steps should be taken to ensure proper function of the detector.

- Test the detector at least once per week.
- Clean the detector at least once a month; gently vacuum the outside of the detector using the vacuum's soft brush attachment.
- If detector becomes contaminated by excessive dirt, dust and/or grime, and cannot be cleaned to avoid unwanted alarms, replace the unit immediately.

⚠ CAUTION

Be sure to replace your detectors by the “replace by” date on the cover, or according to the timeframe listed in the detector’s user’s manual

How To Test

⚠ WARNING

NEVER USE AN OPEN FLAME OF ANY KIND TO TEST THIS UNIT. The built-in test switch accurately tests the unit's operation as required by Underwriters Laboratories, Inc. (UL)

Simply press the TEST switch any time during the warm-up cycle or while in normal operation. The LED should flash red and the alarm should sound. Release the switch. This is the only way you should test your detector. The test feature checks the full operation of the detector. If this detector does not test properly return it immediately for repair or replacement.

This test procedure should be repeated every week or every time the motor home is taken on a trip.



Note: Refer to the detector manufacturer if you have any questions about the Propane Gas Detector.

Checking the Propane System for Leaks

⚠ WARNING

ROAD VIBRATION CAN LOOSEN PROPANE FITTINGS. It is important to check the Propane system for leaks at least every 5,000 miles, and whenever the tank is filled. It is also a good idea to have the entire Propane system checked annually by a qualified Propane service representative.

Use the following steps when checking the system for leaks:

1. Open all the windows and vents.
2. Open the gas tank service valve.
3. Use non-ammoniate, non-chlorinated soap solution, or an approved leak detection solution on all line connections. Ammoniate soap solutions can cause cracking on copper or brass lines and fittings.
4. If a leak is detected, tighten the connection with two open end wrenches until bubbling stops. DO NOT over tighten, or use excessive force. If the leak continues, contact the motor home dealer, or a qualified Propane service representative to have an 11" Water Column Test performed.

Liquefied Petroleum Gas (Propane) is heavier than air and will settle to the lowest point which is generally the floor of the motor home. The detector is also sensitive to other fumes such as hair spray of which most contain butane as the propellant. Butane, like Propane, is heavier than air and will settle to the floor level where it will be detected. When this occurs, press the reset button to stop the alert sound for 60 seconds.

The Propane Gas Detector is powered by the motorhome coach batteries and/or the inverter. The detector will operate properly until the battery is drained down to 10 volts (a low battery condition is 10.4 volts). If the power source (battery and/or inverter) is disconnected, or if the power is otherwise interrupted, the detector will not operate.

The Propane Gas Detector has a self check circuit which runs at all times when the detector is powered. In the event that the circuitry fails, a failure alarm will sound. It is a continuous series of short beep tones between long intervals and is distinctively different from the alert sound.

New Coach Odor: The glues and other materials used in manufacturing the coach produce vapors which may be detected when the coach is closed up. Air out the motor home thoroughly.

Keeps Beeping: The gas detector beeps about once every minute, even when it is turned off. The problem is a weak battery in the smoke detector, similar to the alert sound of the Propane Gas Detector.

Hair Spray Triggers the Detector: Most aerosol hair sprays use butane gas as the propellant. Butane, like Propane, is heavier than air and will settle to the floor level where it will be detected.

Other Gases: Other gases which can cause the detector to respond with an alert include the vapors from any fuel, liquor, alcohol, deodorants, colognes, perfumes, wine, adhesives, lacquer, and most cleaning agents.

Slow Beep Rate: This could be the failure alarm and will occur in the event that the circuitry fails. It is a continuous series of short beep tones between long intervals and is distinctively different from the alert sound.

If the problem still exists: Contact the detector manufacturer for assistance.

TO AVOID EXHAUST GAS ENTRY INTO THE MOTORHOME, KEEP WINDOWS CLOSED WHEN THE CHASSIS OR GENERATOR ENGINES ARE RUNNING.



Most Common Causes of Apparent Malfunction

Identification and Safety



Note: The Propane Gas Detector enters a cleaning and initializing mode every time it is powered. If turned OFF for less than 15 minutes, the Propane Gas Detector may produce several short “chirps” within the first 80 seconds of operation. This is a normal function of the LP Gas Detector.

See your Thor Motor Coach Dealer or a qualified Propane Service Center should service be required. If they are not familiar with this product, have them call the detector manufacturer for assistance. If service is not available in your area, call MTI Industries.

CHEMICAL SENSITIVITY

After you first purchase your new motor home and sometimes after it has been closed up for an extended period of time you may notice a strong odor and chemical sensitivity. This is not a defect in your motor home. Like your home, there are many different products used in the construction of motor homes such as carpet, linoleum, plywood, insulation, upholstery, etc. Formaldehyde is also the by-product of combustion and numerous household products, such as, some paints, coatings and cosmetics. However, motor homes are much smaller than your home and therefore the exchange of air inside a motor home is significantly less than a home. These products, when new or when exposed to elevated temperatures and/or humidity, may “off-gas” different chemicals, including formaldehyde. This off-gassing, in combination with the minimal air exchange, may cause you to experience irritation of the eyes, nose, and throat and sometimes headache, nausea, and a variety of asthma-like symptoms. Elderly persons and young children, as well as anyone with a history of asthma, allergies, or lung problems, may be more susceptible to the effects of off-gassing.

Formaldehyde

Most of the attention regarding chemical off-gassing surrounds formaldehyde. Formaldehyde is a naturally occurring substance. It is also a key industrial chemical used in the manufacture of the numerous consumer products which we referred to above and used in the construction of motor homes. Trace levels of formaldehyde are also released from smoking, cooking, use of soaps and detergents such as carpet shampoos, cosmetics, and many other household products. Some people are very sensitive to formaldehyde while others may not have any reaction to the same levels of formaldehyde. Amounts released decrease over time.

Ventilation

To reduce or lessen exposure to chemicals from off-gassing it is of utmost importance that you ventilate your motor home. Ventilation should occur frequently after purchase and at times when the temperatures and humidity are elevated. Remember off-gassing is accelerated by heat and humidity. Open windows, exhaust vents, and doors. Operate ceiling and/or other fans, roof air conditioners, and furnaces and use a fan to force stale air out and bring fresh air in. Decreasing the flow of air by sealing the motor home increases the formaldehyde level in the indoor air. Please also follow the recommendations contained in “Care AND Maintenance” section regarding tips to avoid condensation problems.



Note: We recommend that you do not smoke inside your motor home. In addition to causing damage to your motor home, tobacco smoke releases formaldehyde and other toxic chemicals.



Note: If you have any questions regarding the health effects of formaldehyde, please consult your doctor or local health department.



Note: Chemical off-gassing is not a defect in your motor home and is not covered by the Limited Warranty. Please follow the recommendation in this section to address this concern.

DO NOT OCCUPY BEDS OR ANY OTHER SEATS THAT ARE NOT EQUIPPED WITH SAFETY SEAT BELTS WHILE THE MOTOR HOME IS IN MOTION. DO NOT USE A SEAT BELT ON MORE THAN ONE PERSON.



SEAT BELTS

ALL OCCUPANTS MUST BE SEATED AT A DESIGNATED SEATING POSITION AND MUST WEAR A SEATBELT AT ALL TIMES WHILE THE VEHICLE IS IN MOTION.



Pilot and co-pilot seats must be locked in a forward facing position with seat belts fastened while the motor home is in motion. Avoid seat rotation while in transit.

The sleeping accommodations in this vehicle are designed for occupancy only while the vehicle is parked. All occupants in this vehicle must be seated at a designated seating position and must wear seat belts at all times while this vehicle is in motion.

Safety belts and seats can become hot in a vehicle that has been closed up in sunny weather; they could burn a small child. Check seat covers and buckles before you place a child anywhere near them.

All occupants must be furnished with and use seat belts while the motor home is moving. However, it is not intended for all seats to be simultaneously occupied while the vehicle is in motion without regard to the total loaded weight of the vehicle. Insert the belt tongue into the proper buckle (the buckle closest to the direction the tongue is coming from) until you hear a snap and feel it latch. Make sure the tongue is securely fastened in the buckle. Adjust the belt to the proper position; snug and as low as possible around the hips, not around the waist. To unfasten, push the release button and remove the tongue from the buckle.

Seat Belt Operation

FAILURE TO INSPECT AND IF NECESSARY REPLACE THE SAFETY BELT UNDER THE ABOVE CONDITIONS COULD RESULT IN SEVERE PERSONAL INJURIES IN THE EVENT OF A COLLISION.



Inspect the safety belts periodically to make sure they work properly and are not damaged. Inspect the safety belts to make sure there are no nicks, tears or cuts. Replace if necessary. A qualified service technician should inspect all safety belt assemblies after a collision. Thor Motor Coach recommends that all safety belt assemblies used in vehicles involved in a collision be replaced.

Maintenance

If your child requires a child safety restraint system (seat), Thor Motor Coach recommends installing the child safety seat in the forward facing booth dinette position. For rear-facing child seats and infant carriers, the dinette table can be placed in the "down" position to allow adequate room for the rear facing child seat. If your motor home is not equipped with a forward facing booth dinette seat, we recommend that small children that require a child seat not be transported in a motor home. Please Note:

Child Restraints

- Rear-facing child seats or infant carriers should never be placed in the front seats.
- Never let a passenger hold a child on his or her lap while the vehicle is moving.
- You are required by law to use safety restraints for children in the U.S. and Canada. If small children (generally children who are four years old or younger and who weigh 18 kg [40 lbs] or less) ride in your vehicle, you must put them in safety seats made especially for children.

Identification and Safety



Note: Check your local and state or provincial laws for specific requirements regarding the safety of children in your vehicle.



Note: Always follow the instructions and warnings that come with any infant or child restraint you might use.

If the child is the proper size, restrain the child in a safety seat. Children who are too large for child safety seats (as specified by your child safety seat manufacturer) should always wear safety belts.

If the shoulder belt portion of a combination lap and shoulder belt can be positioned so it does not cross or rest in front of the child's face or neck, the child should wear the lap and shoulder belt.

Never use pillows, books, or other objects to boost a child.

EGRESS WINDOW

An egress window is designated for use as an exit in the case of an emergency. Inside the motor home the egress window is easily identified by the red locking handles. There are two common styles of latches, determine the style of locking handle you have and refer to the following illustrations for operation. It is also marked as an "EXIT". The glass slider in the egress window operates the same as all other windows;

TEST: The egress window should be opened twice a year to ensure proper operation. Over time, the rubber seal will tend to stick to the egress window. Occasional operation will help prevent the rubber seal from sticking.

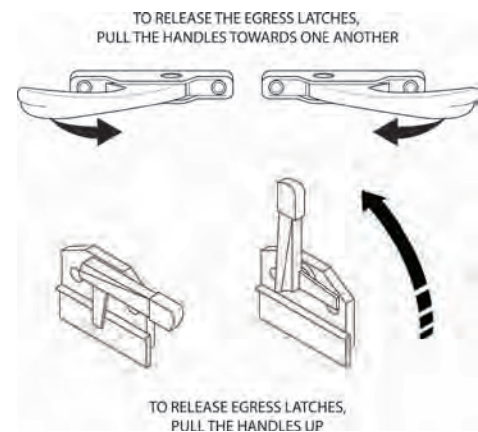

TRAILER TOWING



⚠ WARNING

A SEPARATE FUNCTIONING BRAKE SYSTEM IS REQUIRED FOR ANY TOWED VEHICLES OR TRAILERS WEIGHING MORE THAN 1000 LBS WHEN FULLY LOADED. NEVER EXCEED THE GVWR, OR THE GAWR SPECIFIED ON THE MOTOR HOME CERTIFICATION LABEL. Also never exceed the weight ratings of the trailer hitch installed on the motor home. Failure to heed any part of this warning could result in loss of control of the motor home and towed vehicle or trailer and may cause an accident and serious injury. For specific towed vehicle braking requirements, consult the chassis owner's manual.

THE MOTOR HOME FULLY LOADED AND THE TRAILER, OR TOWED VEHICLE, MUST NOT EXCEED THE MOTOR HOME CHASSIS' GROSS COMBINATION WEIGHT RATING (GCWR). Consult with your selling dealer to determine the GCWR of the motor home. Do not exceed the motor home gross combined weight rating (GCWR) or the hitch rating. The tongue weight, the weight pushing down on the hitch, must not exceed 10% of the hitch capacity.



DO NOT TOW LOADS THAT EXCEED THE GROSS COMBINED VEHICLE WEIGHT RATING OR OTHER TOW RATINGS OF THIS MOTORHOME.



THE DESIGNATED HITCH RATING MAY EXCEED THE GCWR OR OTHER TOWING CAPACITY LIMITS OF THE MOTORHOME. It is your responsibility to properly load the motorhome, while staying within the tow ratings, gross combined and gross vehicle weight ratings.



Always use safety chains between the motor home and the towed trailer or vehicle. Cross chains under the trailer tongue and allow slack for turning corners. Connect safety chains to the trailer or vehicle frame or hook retainers. Never attach chains to the bumper of a vehicle.

Tow bars or car dollies generally are made to travel in a forward direction only. Most towing equipment of this type is not designed for backing. Never attempt short back up distances with a tow bar or tow dolly. Damage to the motor home, towed vehicle or towing device will result.



Note:

Thor Motor Coach accepts no responsibility for damage to the chassis and other components resulting from towing loads greater than its designated class specifications. Also consider the gross combined weight rating of the motor home before towing a trailer or vehicle. Towing an object such as a boat and trailer or a vehicle behind the motor home results in added driving considerations that you must contend with.



 **Note:** All issues regarding the chassis warranty, parts and service should be directed to the chassis manufacturer.

The following section is for reference only. For detailed information regarding product information and proper maintenance of the chassis, refer to the chassis manufacturer's manual.

You as the owner are responsible for taking the proper precautions when attempting any repair or maintenance. If you are not sure what action to take, or are uncomfortable with performing a maintenance or repair function, contact your dealer, or a designated chassis manufacturer servicing dealer. Check information supplied by chassis manufacturer for a service dealer near you.

Special procedures or schedules for "breaking-in" your new motor home are minimal. Make sure to follow the recommendations as outlined in the chassis owner's manual to ensure proper future performance and economy.

 **Note:** Make sure to read all chassis information supplied by the chassis manufacturer, paying particular attention to precautionary notes and warnings, as well as all maintenance procedures and schedules.

IF AN EMERGENCY EVER REQUIRES YOU TO BE STOPPED, BE SURE TO FOLLOW THESE GUIDELINES:

1. Pull off the road as far as possible.
2. Select the Park position and apply the Parking Brake.
3. Turn on the hazard warning flashers.
4. Use three red warning indicators such as flares, reflectors, or lanterns as required by the Uniform Vehicle Code and Model Traffic Ordinance as follows:
 - a. Place the first indicator on the traffic side of the vehicle, directed at the nearest approaching traffic.
 - b. Place the second 100 feet behind the motor home in the center of the lane and toward approaching traffic.
 - c. Place the third 100 feet in front of the motor home in the center of the lane and away from the traffic approaching from behind.
5. Always stand off the road.

 **Note:** Curves and/or hills may effect the safe placement of warning indicators.

EMERGENCY STOPPING

Full operating and service information may be obtained by consulting the engine and drive train operating and service manuals provided by the chassis manufacturer. For maximum engine efficiency and long service life, always follow recommendations, as outlined by the chassis manufacturer. Regular visual inspections can help detect minor adjustments and needed maintenance. All other components of the chassis should be inspected regularly per the schedules set by the chassis manufacturer.

ENGINE AND DRIVE TRAIN

Engine Access



IF THE ENGINE COVER IS NOT SEATED CORRECTLY, EXHAUST GASES MAY LEAK INTO THE MOTOR HOME, CREATING A DANGEROUS AND POTENTIALLY LETHAL SITUATION.

The motor home engine can be accessed for service from inside the motor home. The engine cover between the driver and passenger seats can be removed.

When reinstalling the engine cover, make sure that it is seated correctly without obstruction from carpet, floor mats, etc.

FUELING THE MOTORHOME

Be extremely careful when fueling the motor home. Always shut off the engine, do not smoke, or use cellular phones and shut off all pilot lights before adding fuel. Fuel spills represent a serious fire hazard, and should be cleaned up immediately. Never restart the engine, or relight pilot lights while raw fuel is present. When weather gets cold or the motor home has not been used for a while, a fuel anti-gel additive will be needed.

For your convenience there may be two fuel fills on the motor home. If so equipped, they are located on both sides of the motor home, towards the front of the unit. This allows access into filling stations from either side of the motor home.



Note: If you should lose your fuel cap, it should be replaced as soon as possible, with a cap of the same type.



Note: Always remove the fuel cap slowly and pay close attention to the fuel recommendations outlined in the chassis literature.

Ford Fuel Pump Collision Shut-off Switch

If your motor home is involved in a collision, it is possible that an inertia switch in the fuel pump circuit will open, shutting down the flow of fuel to the engine. This is a safety feature designed to help keep raw fuel from spilling out and creating additional danger. When this inertia switch has been tripped, it is necessary to manually reset it before the motor home can be restarted and moved. Review your chassis owner's manual for the location of the switch and instructions for resetting.

TRAVEL PREPARATION

Like any vacation trip, pre-planning will pay big dividends. In addition to routine trip preparations such as having newspaper delivery stopped and mail held at the post office, there are now more vehicle-related preparations than there are with an automobile.

Chassis Checks

- Fluid levels (oil, power steering, radiator, transmission, windshield washer, etc.)
- Belts (tension and condition)
- Battery (electrolyte level if applicable, connections, charge)
- Hoses (clamps tight, condition, leakage)
- Seals, gaskets (leaks)
- Tire pressure/condition and lug nut torque
- Headlights, running and safety marker lights including brake and turn signal and also any trailer light connections

- Security of any auxiliary equipment such as TV and awning, etc.
 - Windshield wiper blades
 - Generator compartment
 - Fresh and waste water connections/drains and supplies such as high pressure hose
 - Propane compartment/tank
-
- Brakes, including lines, pads/shoes, seals
 - Engine area for pan gasket or other leaks
 - Anything unusual hanging or tangled with road debris such as tree limbs
 - Tank condition (gas, fresh water, waste water)
-
- Check operation of all systems, including: Wipers, windshield, horn, brakes, steering, transmission, heater, defroster, air conditioner, and seat adjustment.
 - Idle engine long enough to check cooling system and alternator operation. Be sure to turn on headlights and climate controls to see if alternator handles the additional drain on the electrical system.



Note: Refer to the Chassis Manufacturer's Owner's Manual for more information.

Pay careful attention to where and what type of flammable materials you store. Certain storage areas are clearly labeled **DO NOT STORE COMBUSTIBLE MATERIALS**. Examples of spark producing areas, depending on the motor home model, are: base kitchen cabinets, front dinette base, exterior refrigerator service compartment, as well as refrigerator cabinet. Please use discretion as to what potentially dangerous products your motor home contains while traveling. Be sure all canisters and bottle tops are secure and leak free.

The following checklist will assist your preparing the living quarters for a trip:

- In winter make sure that the fresh water tank system is freeze protected.
- Make sure that all storage items are secured and that heavy items are stored low so they do not fall.
- Check operation of stove and refrigerator.
- Check that you have proper paperwork such as owners registration card, vehicle registration, proof of insurance, and valid driver's license.
- When preparing for your trip, always consider vehicle weight when loading the motor home.

Exterior Checks

Undercarriage Checks

Operational Checks

Pre-Trip Checklist

On the Road Safety

Use only recommended fuel as specified by the chassis manufacturer. Do not overfill the fuel tank, but allow for expansion of fuel caused by rising temperatures by stopping the filling process when the pump automatically shuts off.

⚠ WARNING

FUEL SYSTEM

Modern fuel systems may build up vapor pressure within the tank as the fuel warms during use, or in hot weather. Under certain conditions, sudden release of this pressure when removing the filler cap can spray fuel from the opening, causing a possible hazard. When removing the filler cap, rotate it slowly, only far enough to allow pressure to release. After any hissing sounds die down, complete the removal of the cap. To protect the gasoline system from excessive pressure or vacuum, or from sudden release of pressure, replace lost caps with caps of the same design available from your motorhome dealer.

⚠ CAUTION

When driving your motorhome, you're driving a large vehicle, and you should become accustomed to the feel of the controls and the reference points from the driver's seat. Become familiar with the position of the motorhome in traffic, and be cautious while maneuvering to allow for the length and width of the vehicle. Always allow extra room to corner and to change lanes. Learn to use the side mirrors to view the road behind. Check them often.

DRIVING

Drive with consideration on the highway, observing all speed and safety regulations. The best cruising speed of your motorhome will vary with road and weather conditions. Remember that your motorhome is heavier than a car, making it less maneuverable and harder to stop. Brake pedal pressure and travel may vary significantly from that of a car. Be prepared to brake earlier than you normally would a car. Also, because of its greater side surface area, it is more easily affected by cross winds. Allow extra distances for passing and stopping, and drive at a moderate speed, particularly in traffic and in gusty wind conditions.

Driving on winding or mountain roads is not difficult if done with reasonable care. Observe proper vehicle speeds when ascending or descending hills and always operate in the proper transmission range. Downshift on hills to avoid overheating or undue engine loads. Downshift before descending grades.

Road conditions, terrain, weather, and other driving factors are sometimes unpredictable, and mountain driving or desert temperatures can put extreme demands on drive train components, especially the transmission. Under extreme heat conditions you may need to turn off the vehicle air conditioner to improve engine and transmission cooling.

Allow for the extra height of your motorhome and avoid areas having low overhead clearance. Check for low hanging tree branches or other obstructions wherever you drive or park. Avoid low roof heights when pulling in for service. This may be particularly important if you drive with the overhead vents open or if the motorhome is equipped with a roof air conditioner, roof rack, or TV/radio antenna. Check the total height for your particular motorhome and make sure that you are aware of it when driving under bridges or underpasses.

When parking parallel to a curb, be sure to allow for poles or obstructions as the front and rear portions of the motorhome will swing wider than an automobile. Remember that your motorhome is larger than your automobile and will require more space. Be careful your unit does not occupy road space or block driveways while parking. When

PARKING

CHANGING TIRES

parking on an incline, turn the front wheels into the curb in the direction of the roll to aid the parking brake. Always set the parking brake when parking.

CAUTION

Changing a tire on a motorhome is more difficult than an ordinary automobile. Motorhome tires are larger and heavier than ordinary tires. Whenever possible, call for roadside assistance to help you in changing your tires. This task should not be done alone due to the weight of the unit. Motorhomes are extremely heavy. Changing a flat tire is best left to a professional mechanic with the proper tools.

If absolutely necessary, change the tire on a level and firm surface. If you are on the roadside, activate the vehicle's hazard warning flashers. Apply the parking brake. Set up flares and or warning lights. See the chassis manufacturer's owner's manual for specific jacking and tire removal, and replacement instructions, which pertain to your unit. Lug nuts vary from chassis to chassis, and the GVW (Gross Vehicle Weight) of your motorhome. (See Chassis Owner's Manual for specific instructions on tightening lug nuts). After operating 50-100 miles, retighten to the same specification. If you don't have proper equipment, stop at the nearest service facility and have the torque of the lug nuts checked.

WARNING

Never place the jack under a bumper or under the edge of the sidewall. Always place the jack as specified by the chassis owner's manual. Never use the rear differential as a jacking point. Use the jack only for changing tires. NEVER get underneath the vehicle when using the jack; never start or run the engine while the vehicle is on the jack.

TIRE CARE

The most important factor in maximizing the life of your tires is maintaining proper inflation pressure. An under inflated tire will build up excessive heat that may go beyond the prescribed limits of endurance of the rubber and the radial cords. Over inflation will reduce the tire's footprint on the road, reducing the traction, braking capacity, and handling of your vehicle. An over inflated tire will also cause a harsh ride and uneven tire wear.

CHECK AIR PRESSURE

To determine the correct air pressure for your tires, load your motorhome as you would normally for travel, including water and fuel. Determine the correct air pressure for the weight on each axle and adjust the pressure according to the Federal Certification Label when the tires are cool or have not been driven for more than one mile. Never reduce the air pressure in a hot tire.

CAUTION

Never let air out of a hot tire.

Now that you have found what the correct air pressure per axle needs to be for your motorhome when loaded, you need to know when to check your air pressure. You should check the air pressure every two weeks or at least once a month and before any major trip. Your motorhome's air pressure should be checked every morning on long trips. On short trips of a day or less of driving each way, your tires should be checked before you start your trip home. If your vehicle is stored for any length of time, the air pressure should be checked prior to storage, but more importantly, when it comes out of storage.

Check your tires when they are “cold” and have not been driven for more than one mile. The stated load capacity for a given cold inflation pressure is based on ambient outside temperature.

To maintain the inflation pressure in your tires you will need the proper equipment. It is recommended that you purchase a quality truck tire air gauge, which has an angled dual head. This type of gauge allows you to check inflation on the inner dual wheel which has the valve stem pointed away from you. Nothing should restrict your ability to check your tire’s air pressure daily when you are driving your motorhome. Pressure sealing valve caps should always be used to prevent air from escaping from the valve stem. If you use valve stem extension hoses, make sure they are good quality stainless steel braid reinforced, and are securely anchored to the outer wheel. If your motorhome has wheel covers which must be removed to check the inflation, then consider removing them as the extra time and effort required may lead you to avoid checking your pressure.

When replacing your tires always make sure the proper size and rating is used. Check the federal certificate located in the drivers area for your model’s specific size and rating.

⚠ WARNING

In a sudden stop or collision, loose equipment could strike someone. Storing a jack, a tire, or other equipment in the passenger compartment of the vehicle could cause injury. Store and secure all of these items in a proper place.

⚠ CAUTION



Note: Thor Motor Coach does not provide jacks with our motorhomes. Any changing of tires should be performed by a professional mechanic with proper equipment.



Controls and Operations

Driving a motorhome is similar to driving a car. You have an ignition switch, gearshift controls, turn signals, and dash components. As you sit in the driver's seat the center of the cluster includes tachometer, speedometer, fuel gauge, oil gauge, temperature gauge, and amp meter. Switches may have symbols to describe their function. Switch locations may be different from model to model.

The dash radio can be played without turning the ignition key "on" provided that the battery disconnect is in the "use" position. For units with the home theater, the dash radio can only be played if the ignition is in the "accessory" or "run" position. The cruise controls are on the turn signal lever. You can set, resume, and disengage the cruise control from this location.

The gear selector is located on the right side of the steering wheel. Pull the lever toward you to place into the desired gear. Be sure the service brake is applied when making this selection. See the Chassis Owner's Manual for more information. Some models have an overdrive switch on the end. Press the button to engage/disengage to overdrive function.

Below are descriptions of the various controls on your dashboard. Please keep in mind that these controls may be located in different positions or not available depending on the model of your particular vehicle.

SUNVISORS: These switches control the sunvisors. Each shade works separately, with each assigned switch. Lower the sunshade to desired level.

HEATED MIRRORS: Use this switch to defrost your mirrors.

ICC: Courtesy Flasher (DOT-Lights): Flash after a semi-truck passes you or as a thank-you flasher when you are passing.

WIPERS: This switch is for HIGH, LOW or intermittent operation.

WASHER: This switch located on to the wiper switch provides washer fluid to the windshield. Check the washer fluid level prior to trips. Some washer fluid can freeze, so be aware of the temperature conditions where you will be traveling in order to add the proper type of fluid to your washer reservoir.

REMOTE MIRRORS: This switch allows you to set the viewing angle of your mirrors from the convenience of the driver's seat. To adjust the driver's side mirror, move the lever to the left. For the passenger's side, move the lever to the right and adjust as needed.

AUTOMOTIVE DASH



GEAR SELECTOR

DASH CONTROLS





FOG LIGHTS/DRIVING LIGHTS: Are offered to provide more visibility. Fog lights will function with low beams, Driving lights will function with high beams.

SIDE DOCK LIGHT: This switch enables the side lights to turn on when the vehicle is in reverse.

NIGHT LIGHTS: Provide lighting in the aisle of the motorhome.

HEADLIGHTS: Operates like the one in your automobile. Turning the knob to the first position turns on the parking lights. Turning the knob to the second position turns on the headlights. Pulling up on the knob turns on the fog lights. Rotating the knob controls the brightness of the dash lights. (Set this according to your preference.)

SERVICE-LIGHTS: Provide under the hood lighting.

AUXILIARY START SYSTEM: Permits using the auxiliary battery power to aid in starting the motorhome engine if the vehicle battery has become discharged. When the ignition key is turned to the start position and one or more clicking sounds are heard, it may be necessary to use the auxiliary start system as follows:

Always set the parking brake prior to using the auxiliary start system.

1. Press and hold the AUX START switch located on the dash.
2. Turn the key and start the engine in the normal manner.
3. Release the AUX START switch and operate motorhome in a normal manner.



Note: Do not hold the ignition key in the start position for more than 30 seconds.



Note: Be careful not to run down the auxiliary RV battery as this could leave you without any 12 Volt power.

DASH FANS: Provide air flow in the cockpit area. They can be of assistance to the defroster system during cold temperatures, or circulate cool air from your air conditioner during hot weather. This is a two speed switch for low and high speed operation.

GENERATOR START: A switch on the dash, in the bedroom or on the generator allows remote starting or shutdown of your power generator. When the generator is running, a light on the dash switch will be illuminated. An hour meter shows the total amount of time the generator has been in operation.

The steering wheel can be moved to allow additional room for entering and exiting the driver's seat, as well as for selected driving positions. To tilt the steering wheel, pull the adjustment lever toward you and move the steering wheel to where you want it. Release the lever and the steering wheel will lock in the new position.

Never attempt to adjust the steering wheel while the vehicle is in motion. Loss of vehicle control could result.

⚠ WARNING

STEERING WHEEL ADJUSTMENT

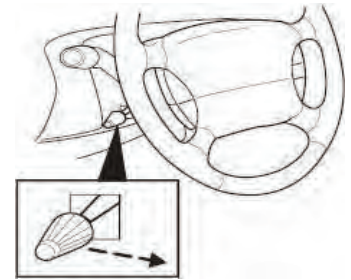

The lever on the left side of the steering column controls the turn signal with lane change feature, as well as the Head lamp high/low beam toggle as well as the windshield wiper and washer fluid dispersal.

The turn signal lever has two off-center positions, one positions upward (for right) and one downward (for left). To signal a turn, move the lever all the way up or down. These are latching positions. The lever will stay in one of these positions until the steering wheel returns back to center as the turn is complete.

To change the head lamps from low to high beams, pull the same lever used for turn signal operation up toward the driver and release the lever. This is a self-returning action. Repeating this toggle action will return to the low beams.

TURN SIGNAL/LANE CHANGE/HIGH-LOW BEAM



The hazard flasher control button is located on the steering column just behind the steering wheel. To activate your hazard flashers, press the button. To turn off the hazard flashers, press the button again.

HAZARD FLASHER CONTROL

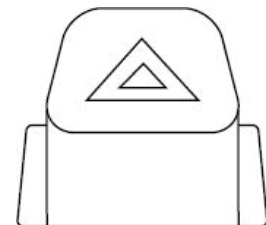

REAR VISION SYSTEM

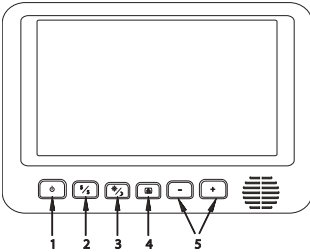

The monitor for the back up camera is located in or on the dash. It will turn on when the gear selector is placed in reverse, or when you engage its power button. It will allow you to see behind your vehicle as you back up or park. The camera is located on the rear cap of the coach.

This system gives a televised view of what is behind the motor home. It is used as an aid in backing the motor home, and can also be used for greater field of vision when driving in heavy traffic. The picture is a representation only. your actual system may look different than that pictured.

Rear Vision Systems vary within our motor homes. Some motorhomes come equipped with a dash radio with a motorized video screen that pops up and displays the back up camera image. Other have separate radios and rear vision systems. Please consult the manuals that came with your coach for specific operating instructions

Listed below is an example of few of the basic commands used.

1. **POWER ON/OFF:** Press once turns unit ON. Press again for OFF.
2. **SELECT:** Pressing button sequences source input modes from CH1 TO CH3.
3. **DAY/NIGHT:** Pressing button sequenced day/night back light.
4. **MENU:** Pressing button gives access to an on screen display menu and the setup menu.
5. **VOLUME:** Pressing button decreases or increases speaker volume.

⚠ DANGER MAKE SURE TO CHECK THE MIRRORS WHEN DRIVING AND BACKING, FOR A MORE COMPLETE FIELD OF VISION. The camera is equipped with a wide angle lens that can initially present an image that may be deceiving. Make sure to practice backing in a safe place, using the monitor to become accustomed to its operation.

Camera Operation

Power Switch:

The power button has two settings, Stand-by and ON. When in the stand-by mode the monitor operates when the recreation vehicle transmission is switched into Reverse. When in the ON mode the monitor system operates when the ignition switch is in the ON position.



Note: The unit will not turn ON when the hazard lights are activated.

CA SEL: (Camera Select Button):

This button is used with the optional side view camera system. Use the button to toggle through the multiple camera views.

Day/Night Mode Button:

Pre-set brightness and contrast levels optimized for day or night operation.

Contrast & Brightness:

Variable controls of contrast and brightness. Should be adjusted if the DAY/NIGHT switch does not achieve the most desirable picture.

Volume:

Variable control of internal speaker volume.

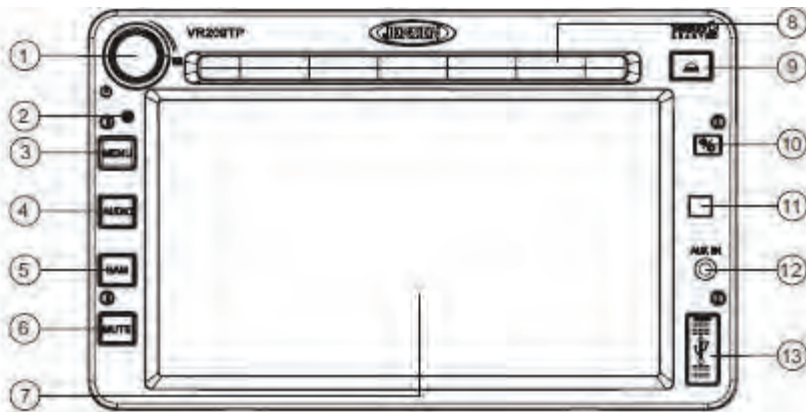

DASH RADIO

The dash radio will control the multi-functions for the dash audio system. Basic Operations are listed below. For complete information, consult your owner's manual provided. Satellite-Ready means that the in-dash radio will work with a satellite radio tuner should you decide to install one.

POWER ON / OFF: Press the Volume/Power button (1) to turn the unit ON and OFF.

VOLUME CONTROL: To increase the volume, rotate the volume control (1) clockwise.
To decrease the volume, rotate the volume control counter clockwise.

MUTE: Press the MUTE button (6) on the control panel to mute the audio output. Mute will appear on the LCD display. Press MUTE again to restore the audio output to the previous level.

AUDIO: Press the AUDIO button (4) to access Audio Mode and select a source for playback. You may press and hold the AUDIO button to enter the "Audio Setup" menu.

ADJUSTING THE CLOCK (DISP): The current time is displayed in the top right hand corner of the LCD display. To adjust the clock:

1. Press and hold the MENU button (3) to view the System Setup menu.
2. Touch the "Clock" field to view the clock set screen:
3. Use the on-screen touch pad to enter 4 digits representing the time.
4. Touch the "AM/PM" field to toggle between AM/PM, if necessary.

RESET: Use a ball point pen or thin metal object to press the RESET button (2). The reset button should be activated for the following reasons:

- initial installation of the unit when all wiring is completed
- function buttons do not operate
- error symbol on the display

AUDIO MENU: Press the MENU button (3) on the control panel to access the User Settings Menu. Each level adjustment is indicated as a horizontal bar graph and an associated numbered level setting. Adjustments are made by pressing virtual buttons at the end points of the bar graph.

The following menu items can be adjusted:

BASS LEVEL: Use the volume control to adjust the Base from -6 to +6.

TREBLE LEVEL: Use the volume control to adjust the Treble level range from -6 to +6.

BALANCE: Use the volume control to adjust the Balance between the left and right speakers from 12L (full left) to 12F (full front).

FADER: Use the volume control to adjust the Fader between the rear and front speakers from 12L (full left) to 12F (full front).

VOLUME LEVEL: Use the volume control to adjust the volume level from 0 to 46.

**AUTOMATIC
HYDRAULIC
POWER LEVELERS**

⚠ DANGER FAILURE TO ACT IN ACCORDANCE WITH THE FOLLOWING MAY RESULT IN SERIOUS PERSONAL INJURY OR DEATH. Read the entire operators manual and all precautions prior to operating this equipment.

Do not use the jacks to change the tires. The system is designed as a leveling and stabilizing system and is not meant to lift the motor home off the ground.

Do not operate any system functions while anyone is under the motor home.

Make sure that people and pets are clear of the coach when operating the leveling system.

Do not attempt to operate the system while the motor home is in motion.

Never place hands or other parts of the body near hydraulic leaks. Oil may penetrate skin causing severe injury. Wear safety glasses when inspecting or servicing the system to protect eyes from dirt, metal chips, or leaks, etc. Follow all other applicable shop safety practices.

The motor home should be parked on a fairly level surface. Ensure that there are no obstructions in the extend or retract paths of the jacks. If the surface is soft due to saturation or heat, place boards under the jacks to distribute the weight over a larger area. Using a board which measures approximately 2' wide by 2' in length is recommended. Ensure the front tires are pointing forward and not to the left or right.

 **Note:** Refer to manufacturer's operations manual before operating.

The automatic hydraulic power leveling system allows quick and easy leveling of the motor home from the driver's seat by utilizing the system touch panel. The following instructions are general operating instructions.

**Automatic Leveling
And Retraction
Procedure**

⚠ CAUTION MAKE SURE THERE ARE NO OBSTRUCTIONS IN THE EXTEND OR RETRACT PATHS OF THE JACKS. KEEP ALL PEOPLE CLEAR OF THE VEHICLE WHILE OPERATING THE LEVELING SYSTEM.

Do not allow excessive motion in the motor home during the Auto-Level operation. This could cause the system to level improperly.

- 1. TURN ON POWER.** The power to the unit must be turned on. You need to have the engine running and the parking brake must be set to turn the control panel on. Push the POWER touch pad to engage power. The power touch pad should be lit when power is on.
- 2. PRESS THE AUTO-LEVEL TOUCH PAD.** The system will automatically level your vehicle. The control panel will send out a series of beeps to let you know that AUTO-LEVEL is operating. When completed, the panel will signal a successful Auto Level. After ten minutes, the panel will enter sleep mode.
- 3. RETRACTING THE JACKS.** Your Lippert System provides you with the ability to retract the jacks using the Retract All Jacks Button feature. Press and retract the Retract All Jacks Button. All jacks will automatically retract. The jacks are retracted when the Jacks Down light has gone out. Depending on the vehicle, full retraction may take up to 90 seconds.

 **Note:** Zero point, or level position has been preset at the factory. However, if you want to change the setting refer to the automatic hydraulic levelers owner's manual for detailed information regarding the proper procedures to do this.

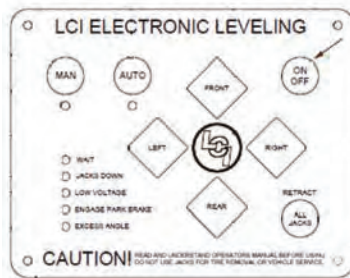
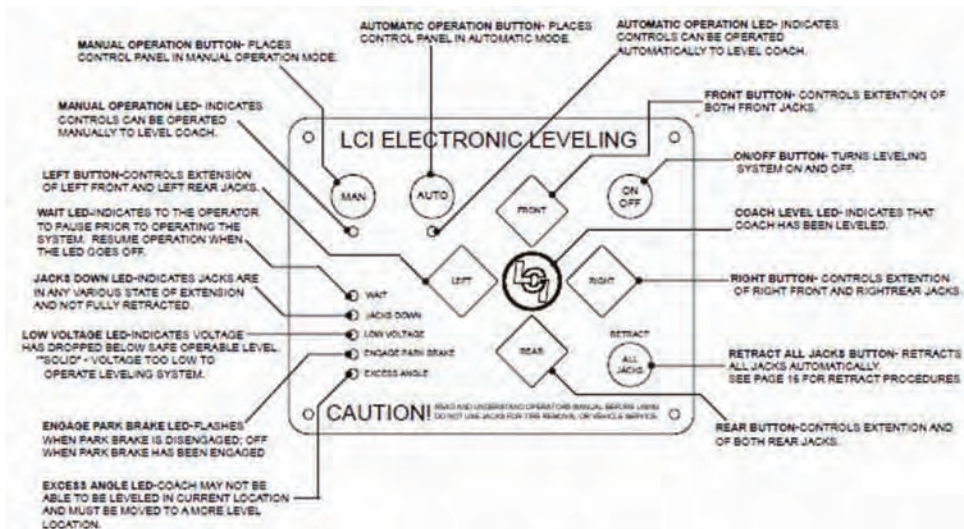

Turn on power

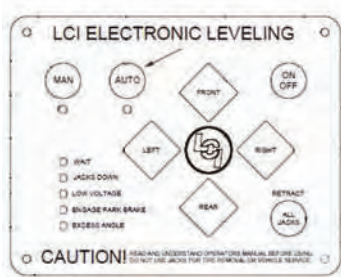

Press auto-level touch pad

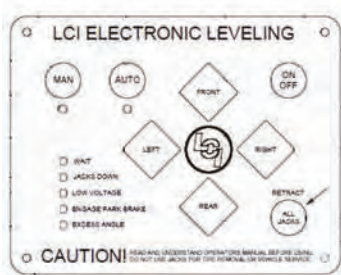

Retracting the jacks

Emergency Retraction Procedure

CAUTION

FOLLOWING MANUAL OVERRIDE OPERATION, FAILURE TO RETURN ALL VALVES TO NORMAL POSITION MAY RESULT IN ONE OR MORE JACK LEGS DRIFTING DOWN FROM THEIR RETRACTED (STOWED) POSITION. FOR CARTRIDGE VALVES, ROTATE THE CENTER SCREW FULLY COUNTER-CLOCKWISE.

In the event of electrical failure, the jack leg(s) may be retracted manually by following the procedure below.

1. The individual cartridge valves are clustered together on the side of the pump manifold.

Locate the screws on the appropriate cartridge valve(s).

Using a 5/32" Allen wrench, turn the screw(s) clockwise until all the way in.



Note: The normal operating position of the screw in the cartridge valve is the counter-clockwise 'out' position. The only time the valve should be shifted manually is when attempting to operate jack(s) via manual override.

2. Remove the plastic cap from the top of the motor and disconnect the power cables.
3. Attach a 1/2" socket to the motor's coupler and drive it with a drill, ratchet or similar device.
4. To retract your jack(s) run the drill in the counter-clockwise direction.
5. To extend your jack(s), run the drill in the clockwise direction.
6. When manual override is complete, return the cartridge valve(s) to the normal positions. Reinstall power cables and plastic cap on motor.



Clockwise for manual override



Counter-clockwise for normal operation

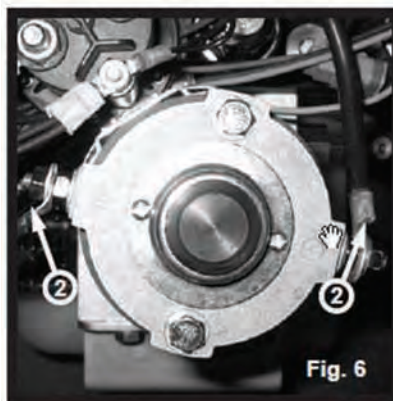

Fig. 6

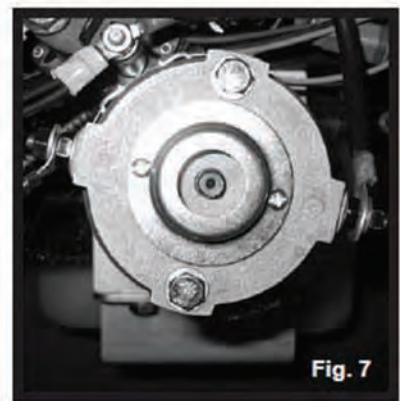
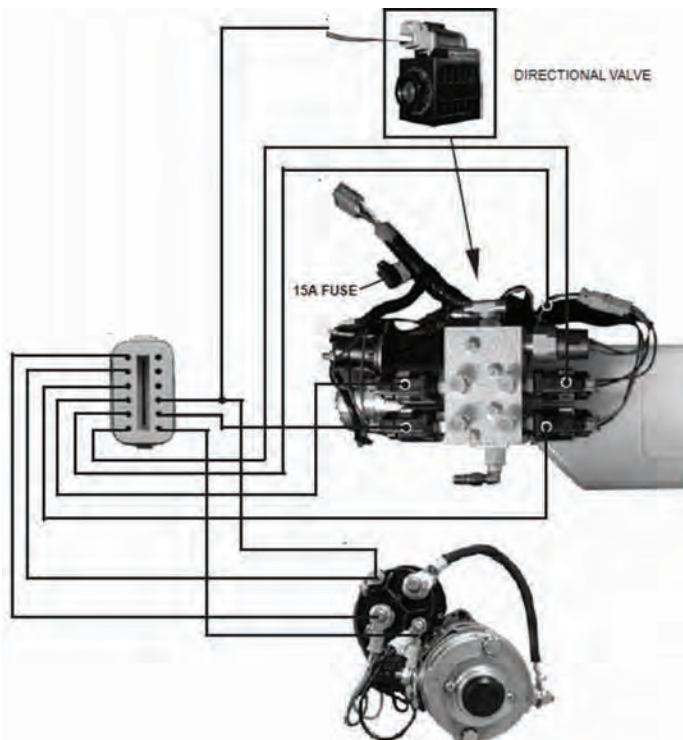
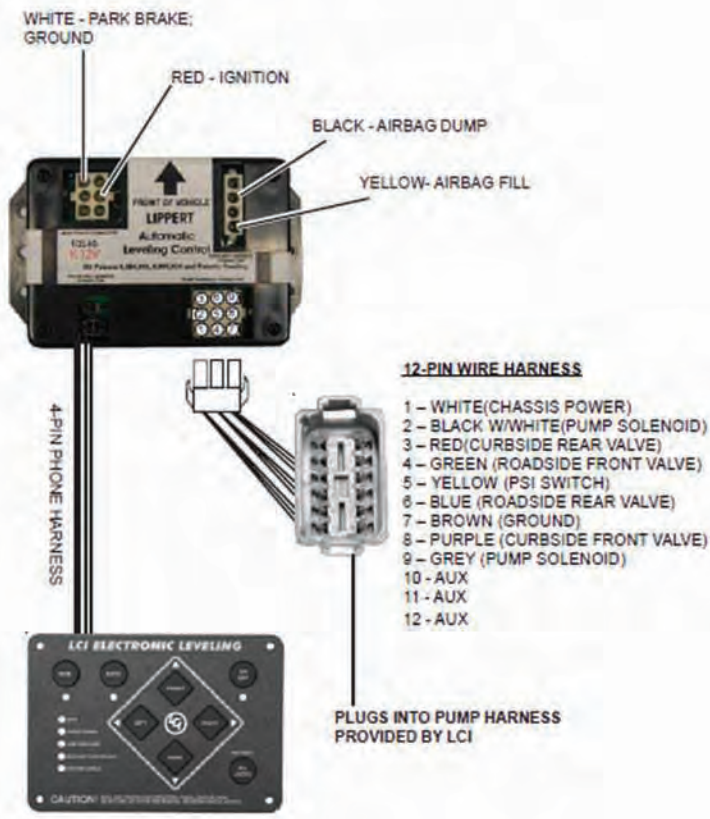

Fig. 7

Hydraulic Pump Function Wiring



SLIDE OUTS

Refer to the manufacturer's operation's manual for complete details and troubleshooting guide.

⚠ DANGER Keep people and obstructions clear of room when operating.

⚠ CAUTION Operating the room with any room locking devices in place can cause personal injury and vehicle damage. It is the operator's responsibility to ensure that all room locking devices (if equipped) are disengaged before operating the room.

⚠ CAUTION The motor home must be level before extending the slide out room(s). Failure to do so may result in structural damage to the motor home or water intrusion.

Electric Slide Out



Note: BEFORE EXTENDING OR RETRACTING SLIDE OUT ROOM: Be sure that the driver's seat is in the forward position and the seat-back is straight up. Slide out room will contact chair if chair is improperly positioned.

To Extend Slide Out



Note: Make sure that there is adequate clearance to fully extend the room.

1. Apply the parking brake
2. Make sure ignition is in OFF position.
3. To extend the room, press and hold the ROOM CONTROL SWITCH in the "OUT" position. When the room is fully extended, release the ROOM CONTROL SWITCH.



Note: Releasing the ROOM CONTROL SWITCH will halt the operation of the room.

To Retract Slide Out

1. Make sure to clear any obstruction in the slide-out area, and set the parking brake.
2. To retract the room, press and hold the ROOM CONTROL SWITCH in the "IN" position. When the room is fully retracted, release the ROOM CONTROL SWITCH.
3. Install the room locking devices if equipped.
4. If the room will not retract, refer to the "Manual Retract Procedure".

Electric Slide Out - Manual Room Retraction Procedure



Note: Please consult Thor Motor Coach for information regarding this procedure.

Keep people and obstructions clear of room when **⚠ DANGER** operating.

In the event that the InWall Slide Unit fails to operate and manual operation is necessary, proceed as follows:

1. Locate the control board.
2. Unplug both motors



3. The room may now be pushed in or out as desired. Larger rooms may need several people to push. Try to keep both sides of the room even. When the room is completely in, plug both motors back in to the controller, this applies a brake to the motors and keeps the room locked in position.

DO NOT MOVE THE MOTOR HOME UNLESS THE MOTORS ARE PLUGGED IN.

⚠ CAUTION

If you are unable to move the room after following the above procedure, then both motors will need to be disengaged.

TO AVOID EXHAUST GAS ENTRY INTO THE MOTOR HOME, KEEP WINDOWS CLOSED WHEN THE CHASSIS OR GENERATOR ENGINES ARE RUNNING.

⚠ DANGER

All the windows that open in the motor home are operated by sliding them back and forth. To operate, pivot the latch to release it from the locked position, and slide the window to open. When closing, slide the window fully closed, and pivot the latch back to the fully locked position. The screens will also slide open and closed if required for an emergency exit.

WINDOWS

 **Note:** Check window sealant during normal washing and per the Care And Maintenance section of this manual.

**InWall Slide Out
Manual Override**

**STORAGE ABOVE
COCKPIT**

Some models are equipped with storage areas above the dash for the VCR, DVD, Global Positioning System, Video Center, CD Changer and Digital Broadcast System. The TV antenna hookup with power booster switch is located here. The light is illuminated when the booster is on. The 120 Volt outlet for the TV is also located here. The video center will allow you to switch the signal from the antenna/VCR to the front or rear television sets.

**LIVING ROOM
TELEVISION**

Where equipped, the front television will only operate when the vehicle ignition switch is turned off. Once the engine ignition switch is on, the television will automatically shut off. This is a safety requirement.

DOORS & DRAWERS

⚠ WARNING

MAKE SURE BEFORE OPERATING THE MOTOR HOME, THAT ALL CABINET DOORS AND DRAWERS ARE CLOSED, AND CABINET CONTENTS ARE SECURE. RETRACT AND SECURE SLIDING DOORS IN THE BATH AREA, AS WELL AS THE BATH DOOR, TO PREVENT NOISE AND/OR DAMAGE WHILE TRAVELING.

Cabinet and closet doors in the motor home have door fasteners or pneumatic stops which prevent them from accidentally opening during travel. Drawers throughout the motor home have travel stops which keep them from sliding out when in motion under normal driving conditions.

When storing articles:

- Always keep tools and equipment stored in areas where they will not shift while traveling.
- Whenever possible, place heavy articles in storage compartments which are low and near the axles for better weight distribution. Pack articles carefully in the storage compartments to minimize shifting. If necessary, use straps to prevent movement.
- Be sure liquid containers are capped and cannot tip or spill. Secure all glass containers and dishes before traveling.
- Store items in the areas designated for storage. DO NOT store anything in the area reserved for the converter and electrical panels or the water tank and pump.

**UNDER BED
STORAGE**

⚠ CAUTION

USE CAUTION WHEN LOWERING THE BED. KEEP HANDS AND FINGERS AT THE END LEDGE PROVIDED and not on the side or further back than necessary, where you may encounter pinch points.

Additional storage is accessible directly beneath the bed. Simply unlatch and lift the foot of the bed. The device is equipped with gas struts to assist with opening, holding, and closing the bed storage lid.

**SLEEP NUMBER
BED**

Sleep Number Bed by Select Comfort™ uses unique air chambers designed to provide a gentle cushion of support. Both sides of the bed can be individually adjusted to the precise comfort level each partner prefers by using the Firmness Control System™.

Fluctuations of the Sleep Number® are normal, and may occur with any of the following:

- Changes in body position on the bed (lying down vs. sitting up).
- Changes in the amount of weight on the bed (one person or two people).
- Changes in barometric pressure or temperature.

 **Note:** It is important to be lying on the bed, in your normal sleep position, when checking or making changes to your Sleep Number®.

 **Note:** The coach must be plugged into the Shore Power or Inverter Power supplied if equipped, for the sleep number bed to function.

- The Firmness Control System™ is designed to make changes to one side at a time. When the Sleep Number® disappears from the wired remote display, changes may be made to the other side.
- To adjust the mattress to a firmer setting, push the UP arrow on the wired remote.
- To adjust the mattress to a softer setting, push the DOWN arrow on the wired remote.
- Some Firmness Control System™ pump models may cycle ON and OFF several times as they find the Sleep Number®. Depending on which digital remote you have, a flashing or blank display means adjustments are still in process.
- The Firmness Control System™ may be heard while making changes to the Sleep Number®.

 **Note:** For detailed information regarding the operation and maintenance of the Select Comfort Mattress, refer to the manufacturer's operations guide.

DO NOT OCCUPY BEDS OR ANY OTHER SEATS THAT ARE NOT EQUIPPED WITH SAFETY SEAT BELTS WHILE THE MOTOR HOME IS IN MOTION. DO NOT USE A SEAT BELT ON MORE THAN ONE PERSON.

WARNING

The sleeping accommodations in this motor home are designed for occupancy only while the motor home is parked. All occupants in this motor home must be seated at a designated seating position and must wear seat belts at all times while this motor home is in motion. Failure to do so may result in serious injury. Safety belts and seats can become hot in a vehicle that has been closed up in sunny weather; they could burn a small child. Check seat covers and buckles before you place a child anywhere near them.

SOFA TO SLEEPER

- Unlatch and remove sofa arms (if equipped).
- Raise the sofa seat base until the seat base and backrest form a “V” shape by lifting up from the center of the sofa just below the seat cushions.
- Pull out and push down on the seat base until the seat base is flat.
- Fold the seat belts out of the way.

SLEEPER TO SOFA

- Lift the seat base up until the seat and back rest from a “V” shape.
- Push back and down on the seat base.
- Position the seat belts for use.
- Replace the back rest cushions.

SOFA TO SLEEPER

- Unlatch and remove sofa arms (if equipped).

Using the Firmness Control System™

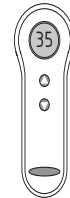

SOFA/HIDE A BED

Sofa bed



Hide-A-Bed Sofa

Space Saver Sofa

- Raise the sofa seat base until the seat base and backrest form a “V” shape by lifting up from the center of the sofa just below the seat cushions.
- Pull out and push down on the seat base until the seat base is flat.
- Fold the seat belts out of the way.

SLEEPER TO SOFA

- Lift the seat base up until the seat and back rest from a “V” shape.
- Push back and down on the seat base.
- Position the seat belts for use.
- Replace the back rest cushions.

SOFA TO SLEEPER

- Grasp the front metal bar and lift up, pulling out on the bar slightly until the leg of the bed is resting on the floor.
- Fold the seat belts out of the way.
- When the legs of the bed are on the floor another lifting bar will be exposed, grasping and pulling the lift bar will open the bed fully.

Hide-A-Bed Sofa

SLEEPER TO SOFA

- Remove all bedding from the hide-a-bed.
- Grasping the foot of the hide-a-bed in the center using the metal lifting bar, lift the front portion of the lifting bar to raise and then lower the hide-a-bed back into the sofa base.
- Position the seat belts for use.
- Replace the seat cushions.

Air Hide-A-Bed Sofa (Drawer Storage Below)

SOFA TO SLEEPER

- Pull back rest section of sofa out and over seat cushions.
- Fold legs up.
- Rotate till legs rest on floor.
- Unfold air mattress, plug in, fill with air.



Note: Do not fold the air mattress up in the sofa. Damage will occur.

Air Hide-A-Bed (No Drawer Storage Below)

SOFA TO SLEEPER

- Remove back rest cushions.
- Pull seat cushion section up and out
- Rotate bottom of seat cushion out and fold legs down.
- Fold back rest down to create platform.
- Unfold air mattress, plug in, fill with air.



Note: Do not fold the air mattress up in the sofa. Damage will occur.

BARREL CHAIR

The barrel chair has controls on the bottom right and left sides under the chair skirt that controls the swivel and side to side action of the chair.

To recline, sit down, grasp the armrest's and lean back to recline. Since a seat belt is not provided, do not use the euro recliner while in transit.

DINETTE

Booth

The dinette will seat four people. Storage and/or various systems components can be accessed from above by removing the seat cushions and lifting the seat supports.

Free Standing

Since the free standing dinette chairs are not secured to the floor, and not equipped

with seat belts, they should not be occupied while the motor home is in motion. These chairs should be stored securely while the vehicle is in motion.

Pedestal

The dinette can also be converted into an additional bed if required. To convert, lift the table top off of the two support posts. Remove the support posts from the floor and lay them down between the seats. Insert the table top between the seats on the ledges provided. Loosen the seat cushion from the Velcro fasteners and slide each together to form the bed. Reverse this process when reconverting to the dinette configuration.

Wall Mounted

This dinette can also be converted into an additional bed. Lift the aisle side of the table and pinch in the pins on the table leg to collapse the leg. Unhook from side wall and swing into place. The table supports on the dinette base. Loosen the seat cushion from the Velcro fasteners and slide each together to form the bed. Reverse this process when reconverting to the dinette configuration.

PILOT AND CO-PILOT SEATS MUST BE LOCKED IN A FORWARD FACING POSITION WITH SEAT BELTS FASTENED WHILE THE MOTOR HOME IS IN MOTION.



WARNING

Avoid seat rotation while in transit.

Reclining Back

A control lever on the left or right side of seat controls the angle of the back rest. Lift up on the lever, lean back to position seat and then release the lever to lock the back rest in place. To return the backrest to upright position, lift up on the control lever. It will automatically return to its normal upright position. **To prevent damage, be sure to return the seat back to its upright position before operating the slide out rooms.**

Seat Swivel

A control lever on the side of seat controls the swivel function. Push the lever forward to release the detent on the swing mechanism. Once the lock is released, the seat may be rotated either left or right.

Forward And Back Adjustment

The forward and back sliding action is controlled by a lever on the lower left side of the seat. To adjust, pull the lever outward to release the latch, and slide the seat to the desired position. Make sure the seat locks into the position you have selected.

Arm Rests

Arm rests can be rotated up and out of the way when not required.



Note: It may be necessary to adjust the sliding position of the seat and the tilt of the back, to enable the seat to be rotated without obstruction from sidewalls or items to the rear. Some models do not allow complete seat rotation.

Some Thor Motor Coach bedroom doors slide conveniently out of the way beside the wall. Thor Motor Coach provides a vinyl travel strap or a slide latch to secure the door while the motorhome is in motion. The door latch is a bayonet type, which is engaged by turning the handle. Some models have an accordion type door which latches to the wall when the door is closed.

Your motorhome may have day/night shades, which are designed to serve a dual purpose. For daytime use, pull down the bottom half of the light colored shade which allows light to enter the motorhome while affording some privacy. For night use, or to shut light out and increase your privacy, pull the top, darker part of the shade down.

The water heater start switch is located on the wall in the galley, bathroom, or monitor panel area. The light illuminates when the switch is turned on. The light goes off when the burner is on and the water is heating. If the light comes back on, the burner is not



CHAIRS

BEDROOM DOOR & LATCH

DAY/NIGHT SHADE

WATER HEATER SWITCH

yet lit. It may take several tries to light the water heater burner. When the element is turned on the red light will glow. Be sure the tank is full of water before using.

KITCHEN CABINETS

For your convenience, there is plenty of storage above and around the range area for canned goods, kitchen utensils, etc. Please ensure that the doors are closed and latched before traveling to prevent the contents from falling out.

KITCHEN DRAWERS

Drawers are designed to ensure that they do not open inadvertently during travel. To open the drawers, pull out until catch releases. Until you get used to the operation of the drawers, you may think that they are stuck.

KITCHEN PANTRY

Some Thor Motor Coach models have a wire framed pull out pantry. To extend this pantry, remove the travel lock pin at the bottom track and pull the pantry rack outward. To prepare for travel, push the pantry rack in and reinsert the travel lock pin.

RANGE



The range cover provides extra counter space and covers the burners when not in use. When opened, it acts as a grease and splash guard. To raise the range cover, lift and push back until it snaps into place. To return the cover to its counter flush position, lift straight up to disengage the holding mechanism, and return it to the original position. The range has a piezo lighter. To operate, turn the burner valve on, then turn the piezo lighter. At that point, the pilot light will remain on for the oven until it is manually turned off. The oven is not self cleaning, and will need routine cleansing. Please do not store anything in your oven, and do not cook while the vehicle is in motion. For further instructions, please refer to the Range Instruction Manual in your Owner's Information Kit.

REFRIGERATOR



The refrigerator in your motorhome runs on either propane gas or electric power. The controls are at the top of the unit. If you use the auto mode on your refrigerator, the refrigerator will operate on 120 Volt power when available, and automatically switch to propane when shoreline is removed. You can control how cold you want your refrigerator to be with the thermostat control. Your refrigerator is equipped for large capacities with plenty of storage shelves and a crisper. The refrigerator requires normal cleaning and care. Please refer to the Refrigerator Owner's Manual in your Owner's Information Kit for more information.

MICROWAVE



The microwave operates on 120 Volt power provided by the generator or shoreline. It will de-program when the power is discontinued and must be reprogrammed when power is restored. For usage instructions, please refer to the Microwave Owner's Manual in your Owner's Information Kit.

KITCHEN SINK



The kitchen sink is much like the one in your home. It may be equipped with a sink cover board which, when in place, increases counter space. Only waste water should be disposed of down the drain. Never put grease, food, or other obstructions down the drain because you may plug the holding tank.

The faucet in your motor coach may be a single lever faucet with sprayer. To use the sprayer, pull out on the head of the faucet. Press the button on top to release the water. To reinsert the hose, gently guide it back to the original position. If you are not hooked up to a pressurized water system at the city water fill, you must turn the water pump switch on. You can find the water pump switch on a bathroom wall or on the monitor panel in the hall. The water pump is a demand pump, so it will only operate when a faucet is opened to release the pressure.

KITCHEN FAUCET



The shower hose has a bracket that keeps the shower head from dropping and contaminating the fresh water system. It also has a vacuum breaker to prevent the head from siphoning water back into the fresh water system. The shower operates just like the shower at your home with two knobs that control the mix and flow of water, and a center valve to divert water into the shower head. A stopper is provided so that you can fill the tub.

SHOWER HEAD & HOSE

The motorhome may be equipped with a washer/dryer hookup for your convenience.

The elevated bed mechanism represents a pinch or crush hazard. Make sure that all extremities are clear and do not stand under the bed during operation bed during operation



**ELEVATED BEDS
Tips For Safe Usage**

Each vehicle with elevated beds has a warning label listing the maximum load capacity.



Failure to comply with the load capacity could cause bed failure which may result in injury.



Bed(s) must be stowed in the “up” position during travel.



Elevated beds may present a fall hazard which may result in injury. Please follow the guidelines below regarding the elevated beds and the use of bed rails.



The elevated bed should not be used as a storage area. using the elevated bed as a storage area may cause the bed to lower while the unit is in transit



Various Thor Motor Coach products are equipped with standard built-in elevated beds or bed loft areas. These beds can be upwards of 4 to 5 feet above the floor level and are often enclosed on one, two, or three sides and sometimes even partially on a fourth side. Because there are so many potential users and different types of elevated bed designs, elevated beds are not equipped with bed rails.

Use Of Bed Rails

We feel that you, as the customer, are best equipped to determine if a bed rail system is necessary or best for you based on your intended uses, the actual users of the elevated beds, and the comfort level of the users.

For those customers who would prefer using an elevated bed with a bed rail, there are numerous bed rail styles, heights, and designs available, even in the style of bumpers, which can be purchased at various retail locations and/or the internet.

When installing a bed rail please make sure that you follow the manufacturers' installation instructions carefully and that you take in to account the size and height of the mattress (either originally installed by Thor Motor Coach or later replaced by you) so that the rails are the appropriate height above the mattress. This is important

because residential mattresses differ in size from the RV mattresses originally installed by Thor Motor Coach. Please also make sure that the bed rail you select allows for adequate room to get in and out of the elevated bed after installation, especially in the event of an emergency.

- Please use sound judgment when allowing children to sleep in any style of elevated bed. Generally it is not suitable for children under the age of 6 to sleep in an elevated bed or bed loft area.
- Discuss proper usage of any elevated bed/electric lift system with your children and make sure they are supervised if playing in the bedroom/sleeping area with elevated beds. Please do not allow horseplay on or under the elevated bed and no items such as hooks, belts, jump ropes or towels should hang from any part of the elevated bed.
- Place a night light in the bedroom/sleeping area so users can see at night when getting in and out of the beds.
- No more than one person should be in an elevated bed at once and make sure you follow the weight restrictions posted on the warning label near the beds.
- Do not allow children to operate the electric bed systems. The lowering and raising of the electric beds should only be conducted by an adult. No person should be on the electric bed when being lowered or raised.
- If you have any questions about elevated beds, electric bed lift systems or bed rails, please contact Thor Motor Coach Customer Service at 877-500-1020.

ENTRY DOOR

When locking and unlocking the main door, there is a dead bolt and a latch bolt which are keyed separately. Unlock both, pull the latch open, and pull out on the door handle. The main entry door is a two piece door. You can use the screen door separately from the main door by unlatching it. Slide the screen handle cover closed to keep insects out of your motorhome. If the door needs adjustment, see a Thor Motor Coach dealer for service.

The entry door consists of both an exterior door and a screen door used for ventilation when the motor home is parked.

⚠ CAUTION DO NOT ATTEMPT TO DRIVE THE MOTOR HOME WITH THE DOORS OPEN. DO NOT DRIVE THE MOTOR HOME WITH THE OUTER DOOR OPEN AND THE SCREEN DOOR CLOSED. The doors may be damaged, and it is a safety hazard.

When driving, it is a good idea to keep the door locked to prevent uninvited entrance from the outside when stopped. Two types of locks may be provided with the outer door. The handle lock for normal security, and a dead bolt lock for additional security. The dead bolt must be locked while driving.

The screen door can be attached to the outer door. A sliding panel on the screen door permits access to the handle on the outer door to prevent unnecessary handling of both doors. Separate keys are provided for both types of door locks. It is a good idea to keep a record of the key numbers in a safe place, should it become necessary to have duplicate keys made.

ASSIST HANDLE

Adjacent to each entry door is an entry assist handle for convenience and safety in entering and exiting your unit.

The electric step is automatic. When the ignition switch is activated, the step will automatically retract. When the door is opened, the step will extend automatically even if the engine is running. If the switch for the step is in the OFF position, the step will fail to operate automatically. If the step malfunctions, check the battery voltage, fuses, switch alignment, and verify that the step switch is in the ON position.

ELECTRIC STEP

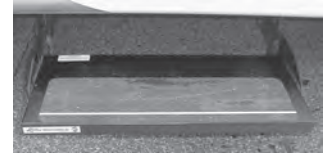

MAKE SURE BEFORE EXITING THE MOTOR HOME, THAT THE STEP IS ACTIVATED AND/OR EXTENDED. DUE TO THE HEIGHT OF THE MOTOR HOME, YOU MAY ACCIDENTALLY SLIP OR FALL IF ATTEMPTING TO EXIT WITHOUT USE OF THE STEP. If the step will not operate, use extra care when exiting. Never activate the step when someone is using it, and be sure to keep hands, feet, children, and pets away from the mechanism when activated.

⚠ CAUTION

If the motor home is driven with the step in the extended position, there is the possibility of causing major damage to both the step and the motor home.

⚠ CAUTION

The entry step features amber lighting under the step, and automatic retraction with the ignition key in the ON position. The power switch for the entry step is located on the passenger armrest.

STEP OPERATION:

1. With the entrance door open, turn the override switch to the OFF position. Close the door. The step should retract and lock in the 'up' position.
2. Open the door. The step should extend and lock in the 'down' position with the under step light illuminated. When the vehicle ignition is turned ON, the step will always activate with the door movement, regardless of the override switch position.

THE UNDER STEP LIGHT OPERATION:

1. The light is ON when the step is extended.
2. The light is OFF when the step is retracted.
3. Turn the override switch to the ON position. The step should remain in the extended position with the under step light OFF when the door is closed.
4. With the override switch turned ON, the step extended, and the entrance door closed, turn the vehicle ignition ON. The ignition override system will go into effect and the step will automatically retract.
5. Turn the vehicle ignition OFF and open the door. The step will extend and lock in the 'down' position. This is the 'Auto Extend' feature.



Note: If the override switch is OFF and the step is extended and the door is left open, the light will turn OFF after five minutes. The under step light is not available on all step models.



Note: If the yellow wire from the four-way connector is not connected to an ignition power source, the ignition safety system will be inoperative and the step will remain in the extended position. In this case, the override switch must be turned OFF for the step to retract.

**COMPARTMENT
DOORS & STORAGE
COMPARTMENTS**

⚠ WARNING If your unit utilizes a side-vented drainage system and you connect to a campground sewage hookup, be sure to keep the drain valve closed. Failure to do so may result in sewer gases being vented outside the RV and into the atmosphere.

⚠ WARNING When closing the storage doors make sure that hands and fingers are clear of pinch points. Make sure all compartment doors are completely closed and latched and that contents are secure prior to moving the motor home.

The motor home is equipped with numerous outside storage compartments. Each door can be locked for security, except for the Propane Gas compartment.



Note: Ensure proper clearance is available for the door to open.

When storing items within the compartment bays, do not overload them with heavy densely packed items, remember that any weight added to the motor home affects the overall weight of the vehicle. Ensure that side-to-side weight is comparable to distribute the load evenly.



Some lower compartment doors may have a pocket latch. To open, simply insert your fingers under the flap and pull up. The door will continue to open on the gas assisted struts until fully open. Push the door to close the compartment, and the latch will close automatically. The doors under the slide-out and doors that are mounted below gas fired appliances with exhaust may have a prop rod so the exhaust does not damage the door. Many models have pass-through compartments for storing longer items. Always keep the doors locked when traveling to prevent accidental opening or theft.

REAR LADDER

⚠ WARNING **DO NOT CLIMB ON OR WALK ON THE ROOF WHILE WET. THE ROOF COULD BE VERY SLIPPERY CAUSING YOU TO FALL, WHICH CAN RESULT IN SERIOUS INJURY OR DEATH. Do not use the roof as an observation platform or storage area, as it is not designed for these purposes.**

Thor Motor Coach motor coaches have plywood reinforced roofs which are strong enough to walk on.

Use the ladder to climb up on the roof for inspecting the roofing seal and components. Take the ladder into consideration when backing up or parking your motorhome.

Where equipped, the exterior rear ladder provides access to the roof for maintenance of the roof and roof mounted items only. When ascending and descending the ladder, ensure the ladder is clear of debris, such as water, ice and other slippery substances. Always wear shoes that provide good traction, and do not wear sandals or other types of slip-on footwear when ascending or descending the ladder.



Note: The rear ladder maximum weight capacity is 250 lbs.

IF THREATENING WEATHER APPROACHES, YOU NEED TO RETRACT ALL AWNINGS. If the awnings are rolled up wet, open them back up as soon as possible to allow them to dry. Do not drive during periods of high winds. Doing so may cause damage to the awning. Any damaged to the awning caused by driving under such conditions will not be covered under warranty.

⚠ CAUTION

IN THE EVENT OF POWER LOSS OR AWNING MOTOR FAILURE THE AUTOMATIC PATIO AWNING CAN BE RETRACTED AS EXPLAINED BELOW. If you do not feel comfortable performing this procedure, contact the nearest authorized service center for assistance. Do not drive the motor home with the awning in the extended position.

⚠ CAUTION

The Slide Out Topper will automatically open and close as the slide out room opens and closes. Because the awning is level, water may puddle on top of the canopy. As the slide out room is closed and the awning rolls up, these puddles may spill over the sides of the awning.



Note: For detailed information regarding the Slide out Topper Awning refer to the Slide Topper Installation And Operating Instructions Manual.

- Release both travel clamps (one on each arm, about midway up)
- Using the provided awning rod, rotate the Safe-T-Lock lever up to the UNLOCK/ OPEN position.
- Hook the awning rod into the pull strap loop securely and pull the awning out. Once extended, slide the pull strap to the right and wrap the strap around the awning arm.



Note: Prior to closing, remove tie downs and screen if used. Ensure that the travel strap and buckle are clear of the back channel.

- Unwrap the pull strap from the awning arm and slide it slightly to the left.
- With one hand, firmly grip the awning pull strap and gently pull down, while at the same time, using the awning rod to rotate the Safe-T-Lock to the UNLOCK/ CLOSE position.
- While holding the pull strap firmly, hook the awning rod into the pull strap loop and slowly allow the awning to retract, controlling the speed with the awning rod in hand.
- Once the awning has fully retracted, reconnect the travel clamps.

- Press and hold the remote switch (located near the entrance door) in the extend position until the awning is fully open or utilize the remote control, if equipped.



Note: Do not press more than one “EXTEND” button at the same time. Awning will not work and/or may cause control box fuse to blow.



Note: Not all awnings have a control box.

AWNINGS

Slide Out Awning

**Manual Patio Awning
Extend the Awning**

Retract the Awning

**Automatic Patio
Awning
Extend the Awning**

Retract the Awning

- Press and hold the remote switch in the retract position. When awning is fully closed release the switch.

Manually Closing the Automatic Awning



Note: Do not press more than one "RETRACT" button at the same time. Awning will not work and/or may cause control box fuse to blow.

Please consult your awning owner's manual for complete instructions or a qualified service technician.



Note: The awning must be serviced by a qualified service technician before attempting to open the awning after this procedure has been performed.

Please reference the owner's manuals and user's guide provided **in your unit packet for detailed operating instructions for specific appliances.**

CABLE HOOKUP/ PHONE JACKS



Many RV parks have cable television and telephone jack connections available. This will enable you to watch cable television in either the bedroom or the living area by utilizing the video selector box in the dash overhead. It will also allow you to access a telephone jack hookup. Simply plug in the TV cable or telephone cord into the outside cable and telephone receptacle.

GENERATOR COMPARTMENT



The generator compartment is located in a storage compartment on the side of the motorhome. You can start/stop the generator from outside the unit by pushing the start button in and holding it until you hear the generator start/stop. Refer to the Generator Owner's Manual for operating and maintenance information.

FURNACE DOOR



The furnaces used by Thor Motor Coach have electronic ignition, and there is no need to access this panel except for service. As with all appliances, service is best left for your dealer. To remove the panel to check for insect nests, you will need a Square or a Phillips head screwdriver. For further information, reference the furnace manufacturer's manual provided with your vehicle.

WATER HEATER DOOR



You can gain access to the water heater control panel to check for insect nests by turning the tab at the top and allowing the door to hinge down. Due to the electronic ignition, it is no longer necessary to access this compartment for lighting the pilot. It has an electronic module board, electronic ignition lighter, and a safety pop-off valve to relieve the pressure, should it be necessary.

REFRIGERATOR DOOR



The refrigerator is an electronic ignition appliance and there is no need to access this panel except for service or checking for insect nests. If a problem is encountered, follow the guidelines for use as outlined in the Refrigerator Owner's Manual located in the Owner's Information Kit. If the problem is not resolved, contact an authorized Thor Motor Coach dealer.

Entertainment

Your coach may be equipped with various audio visual components. Due to the large variety of equipment and variation in installation this section should be considered a general overview of the entertainment equipment. If you are having A/V issues please refer to the component specific user's guides that were included in your unit pack. If you cannot find a resolution to your issue you may contact a Thor Motor Coach Dealer with questions or contact the Thor Motor Coach Customer Service Department at 877-855-2867.

TELEVISION



Thor Motor Coach offers many different configurations and locations for the televisions depending on the floor plan of the unit. These may include; swing out cab over televisions, small televisions in the bunk bed area, and a removable television in the bedroom that may be moved to the exterior of the Motorhome. Please consult the television user's guide that was provided in your unit packet for detailed operating instructions

HOME THEATER SYSTEM

Your Motorhome may be equipped with a home theater system. This system offers a DVD Player as well as auxiliary speakers. Please consult the user's guide that was provided in your unit packet for detailed operating instructions.

EXTERIOR ENTERTAINMENT CENTER



Your Motor home may be equipped with an exterior entertainment center. This entertainment center may contain the following; radio/CD Player, television, DVD player and speakers. Please consult the user's guide that was provided in your unit packet for detailed operating instructions of the various components that make up the exterior entertainment center.



Note: These components are not waterproof. Be sure to safeguard against moisture intrusion from rain and other precipitation.

VIDEO SWITCH BOX



Your Motorhome may be equipped with a video switch box. This box will allow you to switch between different inputs without disconnecting and re-connecting components. Please consult the user's guide that was provided in your unit packet for detailed operating instructions.

TV HOOK-UP



Your motorhome may have an exterior TV hook-up located in a storage compartment. There is a coax cable located in this area to hook your satellite or park cable up to.

SAMPLE A/V HOOK - UP DIAGRAMS

The following two pages contain examples of the audio/visual hook-ups used in Thor Motor Coach Units. The charts shown may differ from that of your unit due to the differences in floor plan and options that may or maynot be installed on your coach. If you have questions about the audio/visual hook-ups for your unit you may contact Thor Motor Coach Customer Service at 877-855-2867.

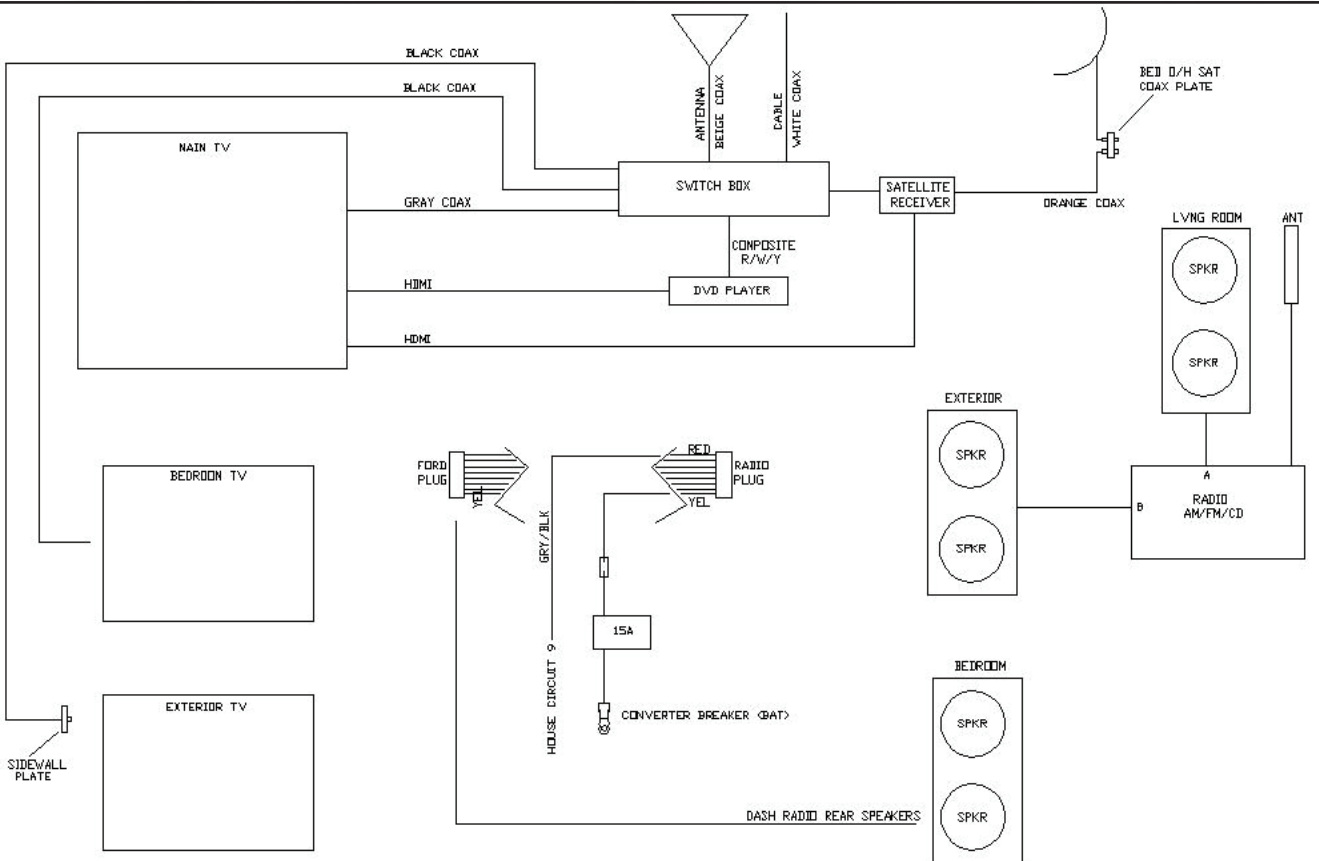
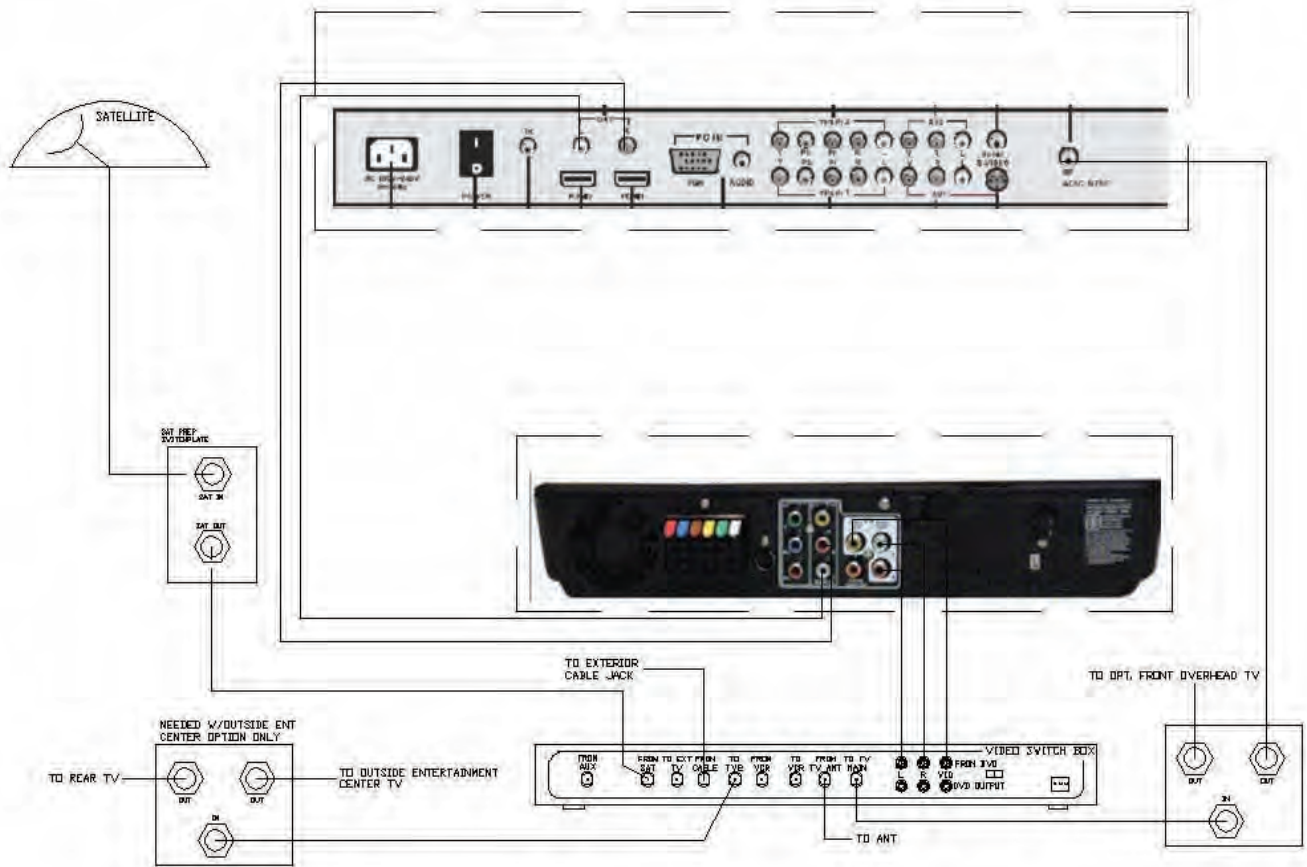

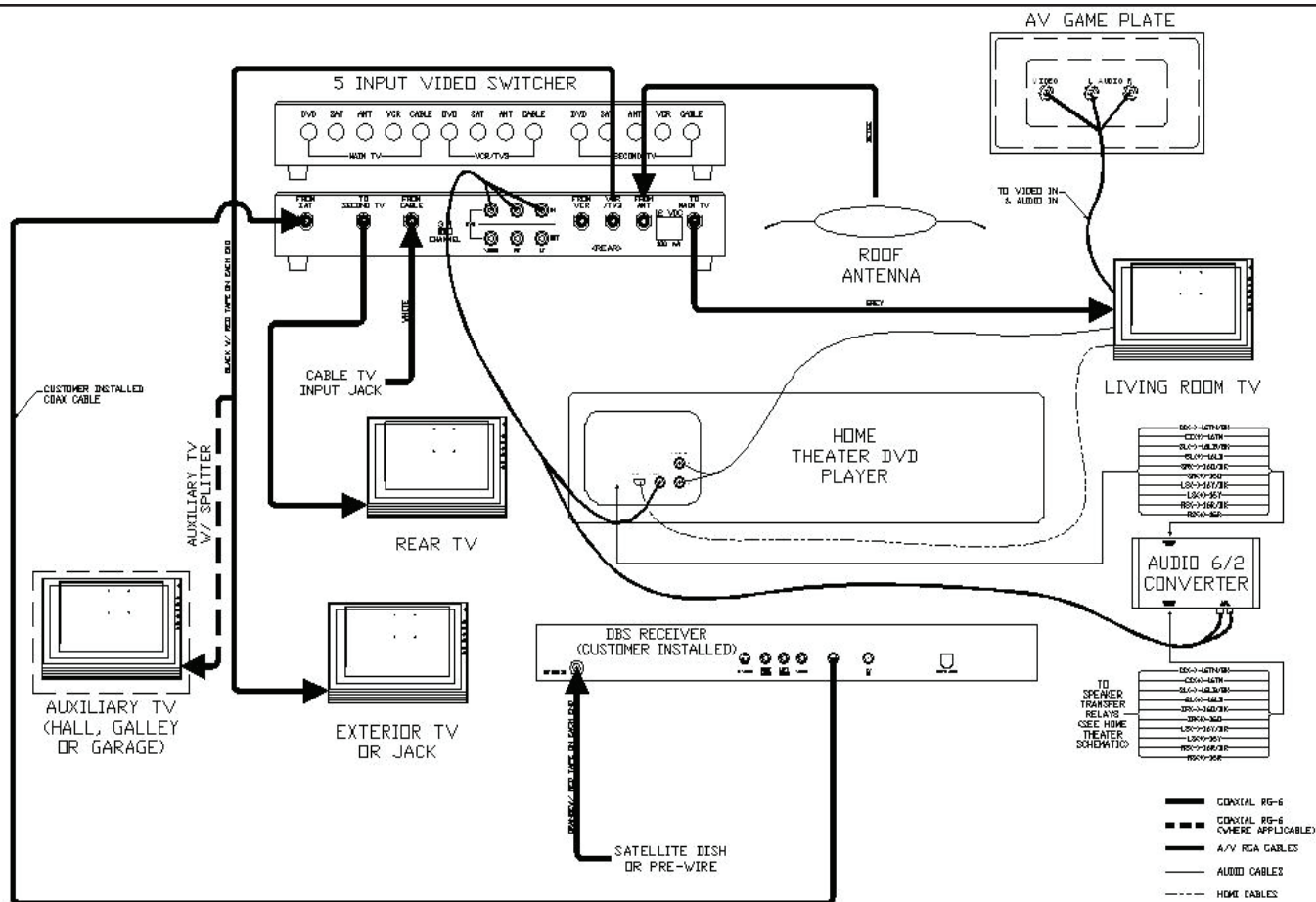
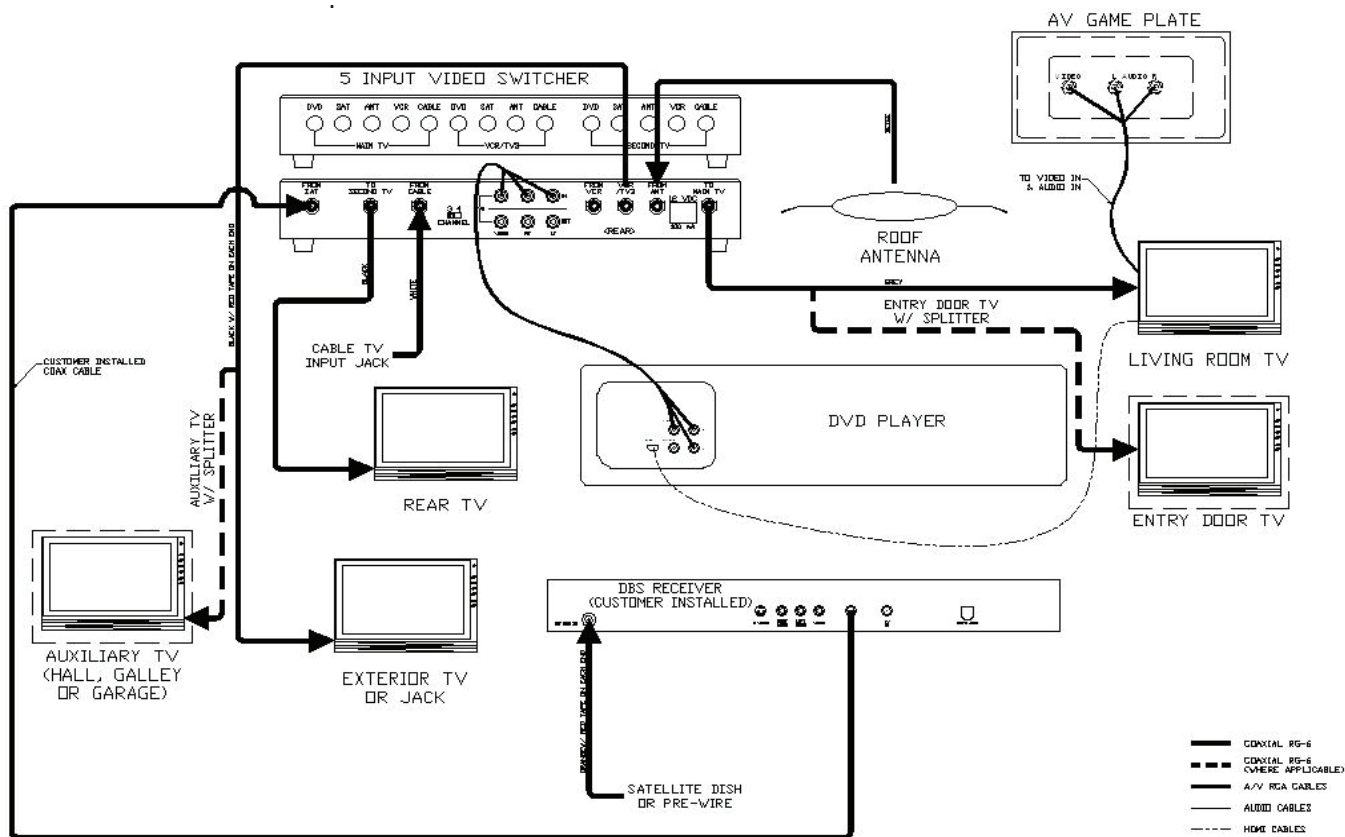

Heating and Air Conditioning

The air conditioning system contains refrigerant 134a under high pressure and should be serviced by qualified personnel only. Improper service methods could cause serious personal injury.

The motor home is equipped with an integrated heating/air conditioning system. While this system is much more powerful than those used in passenger cars, it is not capable of heating and cooling the entire motor home. This system is designed to provide windshield defrost as well as heating and cooling for the front seat occupants only. By following the operating instructions and tips, this heater/air conditioner will provide many years of comfort and dependable service.

The heater/air conditioner unit is located beneath the dash on the passenger side of the vehicle with heating and cooling coils located on the outside of the fire wall. In most modes of operation the unit takes fresh air from outside, and heats or cools it before discharging into the motor home. Only when operated in the MAX A/C mode does the system take air from inside the motor home.

The control panel enables the driver to control the temperature, volume and direction of the air discharged from the heating/air conditioning system.

One of the best ways of controlling temperature is by changing the speed of the blower. The blower knob (left of center) provides 4 speeds in any mode except OFF. The center knob controls the temperature of the discharge air. Turn the knob to the right (red area) for warmer air, and to the left (blue area) for cooler air.

The air conditioning system is designed to operate in all modes except VENT, FLOOR and OFF. This provides significant moisture, dust and pollen removal for enhanced passenger comfort. Use MAX A/C and HI blower for quick cool down. A lower blower speed produces cooler air. To assist with cooling, close all windows and vents to hot, humid outside air.



Note: The A/C will not function if the outside air temperature is below approximately 40° Fahrenheit.



Note: In the event control vacuum is lost, the system is designed to discharge through the defrost vents.

To achieve the maximum comfort in the motor home, the air must be directed where it is needed. The mode switch (right of center) gives the driver the ability to select where the air will flow.

Keep the condenser and radiator free of bugs and debris. During periods of little use, operate the A/C system monthly to keep the compressor lubricated. Periodically inspect belts and hoses for wear and proper tension.

If repairs are necessary during the terms of the motor home warranty, please contact the nearest authorized Thor Motor Coach dealer for service. In the event repairs are necessary during transit, contact Thor Motor Coach Customer Service. Certain individual parts of the Heating and Air Conditioning System such as the compressor, dryer and condenser are covered under the chassis manufacturer warranty.



Note: Components covered under the Thor Motor Coach Limited Warranty must be Original Equipment Manufacturer (OEM) parts. The installation of after market components, or unauthorized repairs may void the warranty.

DASH PANEL HEATER AND AIR CONDITIONER

Control Panel



Operating Features

Warranty/Service

ROOF MOUNTED AIR CONDITIONER

The motor home is equipped with a roof mounted air conditioner. This air conditioner operates from 120 Volt AC only, either from shore power or the on-board generator. Air conditioner functions are controlled by the comfort control panel.

Performance Characteristics

You can expect to see up to 15 to 20 degree differences in temperature between the closest A/C outlet vent and the return air inlet grill under most operating conditions.

Factors that can affect the performance of the cooling system:

- Use window and patio awnings when outside ambient temperature is above 95° F to help deflect the Sun load during the heat of the day. If window awnings are not installed then use shades or blinds to deflect the Sun.
- Try to avoid using the cook top or oven when the ambient temperature is over 95° F.
- Keep windshield covered when facing the afternoon Sun when parked.
- The number of windows within the slide outs and the number of cold air registers to handle heat gain when facing the afternoon Sun.

Return Air Filters



Note: DO NOT USE HARSH CHEMICALS OR SOLVENTS TO CLEAN THE FILTER.

Clean the return air filters as needed for the environment in which they operate. The return air filters are inside the air intake vent covers located on the motor home ceiling. Never operate the air conditioners without the return air filters in place. Doing so may result in the build-up of dirt on the evaporator core affecting the performance of the air conditioner.

FURNACE

TO CLEAN: Remove the vent cover and filter and wash in warm soapy water. Rinse the filter and cover thoroughly with fresh water and allow to dry. Reinstall the filter and cover.

⚠ CAUTION

THIS APPLIANCE IS EQUIPPED WITH AN ELECTRONIC IGNITION DEVICE WHICH AUTOMATICALLY LIGHTS THE BURNER. DO NOT TRY TO LIGHT THE BURNER BY HAND.

⚠ CAUTION

Heat registers can reach high temperatures when the furnace is running and can cause a burn if skin is in contact with the register.

Furnace Operation Instructions

1. The propane tank must be filled and the house batteries should be fully charged.
2. The propane valve located on the propane tank must be in the open position. The valve should only be opened or closed by hand. If the valve cannot be turned by hand, have the valve checked by a qualified service technician.
3. All power to the appliance should be on. Breaker and 12 Volt fuse locations vary depending on floor plan.
4. Set the thermostat to the desired function and temperature setting.



Note: For detailed information regarding the Furnace refer to the manufacturer's operating instructions manual.

 **Note:** For detailed information regarding the thermostat refer to the manufacturer's operating instruction manual.

Certain roof mounted air conditioners have self contained thermostats and controls which are located at the return air grill.

A Cool, Fan and Heat thermostat, with a manual, "Cool", "Fan" and "Off" and "HEAT" comfort switch. The thermostat can be operated in both manual (ON) and automatic mode (AUTO), on either high or low. Set your temperature using the up or down arrow buttons to the right of the digital teperature display.

 **Note:** Refer to the operation manual for proper long term storage procedures.

Vents are provided in the motor home to circulate fresh air and exhaust odors. The power vent includes a 12 VDC powered fan. A hand crank controls opening and closing and adjustment of the vent cover, while a push button turns the exhaust fan ON and OFF. Make sure to turn the fan OFF before closing the vent. Also be sure to remove any debris that falls into the vent that may restrict operation. It is extremely important that you use the fans and vent every time you use the shower or tub to eliminate excess condensation.

 **Note:** For best results, close all other roof vents and open one window, or door the greatest distance from the exhaust vent.

 **Note:** The dome must be open prior to operating the fan motor.

The fan is a three-speed fan which can extract air from the motor home. To operate the fan use the following guidelines:

- Turn the fan speed control dial to the desired performance level. If the "0" setting is selected the fan acts as a vent only.
- Slightly open a window for maximum air flow.
- Set your interior temperature on the wall mounted thermostat between 60° F and 90° F. When the interior temperature is warmer than setting, the dome opens automatically and the fan blade turns on to the pre-selected speed.
- If your vent is supplied with a rain sensor, no other action is necessary on your part in the event that the rain sensor has moisture on it.

Use the dome hand crank knob only in an emergency for dome adjustment. Pull the knob to the desired dome placement. Push the knob back upward. Ensure that the knob is locked in place.

 **Note:** A vent cover or foam filter is not recommended on a Fantastic Vent.

THERMOSTATS



CEILING VENTS

Exhaust Vent

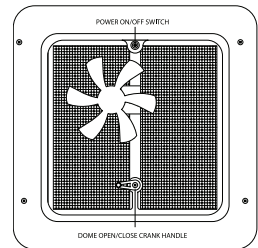

Attic Fan - Fantastic Vent

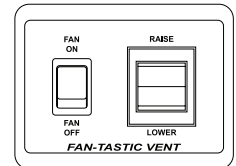

Manual Dome Operation

Attic Fan - Create A Breeze

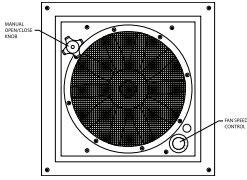

The fan has three speeds.

- Open dome approximately 3 inches or more by turning the hand crank. The fan has a built in safety switch that will not allow motor to operate unless dome is partially open.
- Turn 3 speed knob to desired performance level (0 - Off, 1 - Low, 2 - Medium, 3 - High)
- Slightly open window of your choosing for maximum air flow.

Recommendations: You may use your Create A Breeze while driving or in windy conditions. In this case keep your dome fully open.



Note: A vent cover or foam filter is not recommended on vent.



Note: Refer to the owner's manual for complete instructions and proper long term storage procedures.

Electrical Systems

The electrical system in your motorhome is designed and built in accordance with the latest codes, standards, and regulations effective at the time of construction. It consists of two types of systems, alternating current (AC) 120 Volt service and direct current (DC) 12 Volt service. Because of the many model variations and options, it is not possible to provide wiring diagrams in this manual. We recommend that any electrical work be done by a Thor Motor Coach dealer or a qualified RV electrician.



Note: The electrical system is engineered and tested for safety. Circuit breakers and fuses protect the electrical circuits from overloading. If you plan to make modifications or additions to the electrical system, Thor Motor Coach strongly recommends consulting a certified electrician for assistance to ensure continued integrity and safety of the electrical systems. Please note that any modifications may void the Limited Warranty.

The electrical power supply provided for the motor home is a dual system, operating with 120/240 volt AC and or 12 Volt DC. The 120 Volt power may be provided by either connecting the motor home to an outside power source when parked, or by use of a motor home generator. When the 120 Volt system is operational, power also passes through a system converter, allowing the full use of all 12 Volt functions in the motor home.

120 Volt appliances in the motor home include the refrigerator, ice maker, roof mounted air conditioner(s), TVs, DVD player, microwave oven, converter and the water heater. The refrigerator also has the option of running on propane gas when 120 Volt power is not available. All other electrical functions in the motor home are supplied with 12 Volt power.

When it is not possible to access 120 volt power, the 12 Volt system functions can be supplied by the auxiliary batteries. The chassis battery is protected by a battery isolator controller to prevent discharge from excessive electrical consumption when the motor home is not running. The auxiliary batteries are recharged by the power converter when the motor home is attached to an outside 120 volt power source, or by the generator when it is running, and by the chassis alternator when the chassis engine is running.



Note: These three shore power outlets are most commonly used throughout the United States.



50 Amp



30 Amp



15-20 Amp

SHORE CORD

CONNECTING THE SHORE CORD TO A NON-GROUNDED OR IMPROPERLY GROUNDED POWER SOURCE CAN RESULT IN DANGEROUS AND POSSIBLY FATAL ELECTRIC SHOCK. Due to the potential danger in failing to heed this warning, the motor home manufacturer cannot be responsible should damage, injury, or death result from failure to connect the power cord to a properly grounded power source.

⚠ DANGER

⚠ WARNING DO NOT USE A STANDARD HOUSEHOLD EXTENSION CORD TO CONNECT YOUR MOTOR HOME TO ELECTRICAL SERVICE. IF SHORE POWER SERVICE IS LIMITED TO 15 OR 20 AMPS, USE OF LIGHT DUTY EXTENSION CORDS AND ELECTRICAL ADAPTERS WILL CREATE A VOLTAGE LOSS THROUGH THE CORD AND AT EACH ELECTRICAL CONNECTION. Line voltage loss and the resistance at each electrical connection can be a hazardous combination. Damage to sensitive electronic equipment may result.

30 Amp Shore Power

⚠ WARNING THE MOTOR HOME IS DESIGNED TO BE CONNECTED TO A 30 AMP SERVICE WHICH PROVIDES 120 VOLTS. The motor home should never be connected to any power source that will provide anything more than 120 Volts. Failure to follow this will result in serious damage to internal items that are plugged in.

A 30 amp shoreline power cord is provided to attach the motor home to a grounded power source. When connecting or disconnecting from a grounded external power source, always turn off the shore power breaker to the power supply outlet. This will prevent accidental shock and flashing of electrical contacts.

50 Amp Shore Power

⚠ WARNING THE MOTOR HOME IS DESIGNED TO BE CONNECTED TO A 50 AMP SERVICE WHICH PROVIDES A COMBINED TOTAL OF 240 VOLTS. The 240 Volts comes from two separate 120 Volt lines that are in the shore power cord. The motor home should never be connected to any power source that will provide anything more than 120 Volts on either line coming in. Failure to follow this will result in serious damage to internal items that are plugged in.

A 50 amp shoreline power cord is provided to attach the motor home to a grounded power source. When connecting or disconnecting from a grounded external power source, always turn off the shore power breaker to the power supply outlet. This will prevent accidental shock and flashing of electrical contacts.

BATTERIES

The chassis and or auxiliary batteries of a motor home may be located behind the front hood of the motor home or in an exterior compartment. Please note that Sprinter chassis batteries are located inside the cab area underneath the driver's seat.

Battery Safety

It is important to make sure that batteries are kept charged. Take time to turn off all lights or other 12 Volt conveniences when not in use. Connect the motor home to a 120 volt power supply when possible, instead of draining the batteries. The charge condition of the batteries can be checked with the monitor panel. To check, press and hold monitor test switch while reading the charge level on the battery gauge. Charge levels indicated are divided into sections from weak through fully charged. When shore power is unavailable, the coach batteries power all house 12 Volt devices. The coach batteries are of the golf cart variety and are capable of being deeply discharged. With a large reserve rating, the batteries are able to provide limited use for several days before needing to be recharged. Because of the large power rating, the batteries must be recharged for a minimum of 24 hours to reach a full charge.

BATTERIES CAN EXPLODE! Always wear splash proof safety glasses when working near batteries. Do not smoke or expose any battery to electric sparks or flame. Batteries, when charging or discharging, generate hydrogen. Hydrogen and air is a very explosive mixture.

⚠ DANGER

DO NOT SHORT ACROSS THE BATTERY TERMINALS. The spark could ignite the gases. Do not wear metal jewelry or a watch when working on a battery. Before doing ANY work on electrical system, disconnect battery cable and the 120 volt power cord. Do not reconnect the cables until all work has been completed. This will avoid the possibility of shorting or causing damage to electrical components or shock to the servicing person. Battery electrolyte is a corrosive, poisonous, sulfuric acid. Avoid contact with skin, eyes, clothing, or any painted surface.

⚠ WARNING

Sulfuric acid in the batteries can cause severe injury or death. Sulfuric acid can cause permanent damage to eyes, burn skin and eat holes in clothing. Always wear splash-proof safety goggles and gloves when working around the battery. If battery electrolyte solution is splashed in the eyes, or on the skin, immediately flush with clean water for 15 minutes. In case of eye contact, seek immediate medical treatment. Never add acid to a battery once the battery has been placed in service. Doing so may result in hazardous splattering of electrolyte solution.

⚠ WARNING

Battery maintenance is important. Checking the condition of a battery at regular intervals will help insure its proper operation. Here are some recommendations for checking and servicing batteries:

Battery Maintenance

 **Note:** These instructions apply only to batteries which are not maintenance-free batteries. Do not open or break seals on maintenance-free batteries.

1. Keep the battery mounted securely. Vibration causes early failure of many batteries.
2. Check the electrolyte level of the auxiliary batteries at regular intervals. Keep each cell filled to just above the plates with distilled water. Once the plates have dried out, they cannot be reactivated, and the capacity of the battery is reduced in direct proportion to the area of plate surface that has become dry. This kind of damage can occur quickly; usually it can happen overnight. If the fluid level is low, simply add distilled water.
3. Keep the battery clean. Corroded terminals make poor contact and do not allow the chassis alternator or the converter to bring the battery up to full charge. Battery sulfation occurs when the battery has been standing in a discharged condition over a long period of time, or when the battery has been operated continually in a state of partial discharge. Use a baking soda solution to neutralize the acid accumulations on the battery top. Do not allow the soda solution to enter the battery. Make sure the vent caps are secure. Flush with water. Thoroughly dry all cables and terminals, reinstall, and use a plastic ignition spray to protect the terminals.
4. Check the outside condition of the battery. Look for cracks in the case or

vent plugs. If the case is cracked, the battery must be replaced. If the vent plugs are cracked, they must be replaced.

5. Watch for overcharging. Three indications of overcharging are:
 - a. Active material on the vent cap (heavy deposit of black lead-like material on the underside of the vent cap) .
 - b. Excessive use of water.
 - c. Voltage regulator output.
6. Make sure the battery hold downs and carrier are kept clean and free of corrosion.

When removing a battery, disconnect the ground battery clamp first. When installing a battery, always connect the grounded battery clamp last.

When a battery needs to be replaced, make sure to replace it with a battery of the same characteristics as the original equipment. Consult your dealer for advice on battery replacement.

WARNING

ALWAYS WEAR SPLASH PROOF SAFETY GLASSES WHEN WORKING WITH BATTERIES.

Battery Isolator Controller

When the motor home engine is not running, the chassis and auxiliary batteries are kept separated from each other within the electrical system through the use of a battery isolating controller. The controller prevents the auxiliary batteries from discharging the chassis battery when the motor home is parked.

Some additional characteristics of the isolator system include:

1. Delays connecting the auxiliary batteries to the charging system for approximately 15 seconds, to allow the alternator time to reach full charging ability.
2. After this initial time delay, if the alternator has come up to full charging ability, (13.2 Volts) the isolator will electrically connect the auxiliary and chassis batteries together for charging.
3. If the charging voltage drops below 13.2 Volts for a period of 4 seconds due to low idle speed and or excessive load, the isolator will disconnect the auxiliary batteries until the voltage returns to a level of 13.2 volts for about 10 seconds.
4. In the event the automotive battery is discharged, it will be necessary to press and hold the Start Switch located in the dash.



Note: When operating 12 Volt equipment from battery, reduce equipment in use to conserve battery. Gradual dimming of lights, and slowing of motors indicates low battery voltage.

The converter/inverter also operates as a battery charger when it is connected to a 120V power source. If the battery is below its full charge, the converter/inverter charger will begin operation at a rate that reflects the level of discharge. When the battery is again fully charged, the converter charger drops its charging level back to a maintenance level to keep the battery fully charged.

If for any reason you charge a battery with a source outside the motor home, make sure to follow the rules of battery maintenance and safety outlined in this section. Also observe these additional safety precautions related to battery charging:

1. Disconnect the battery from the motor home.
2. Check electrolyte before charging. Be sure each cell is properly filled with distilled water.
3. Make sure to use care when connecting and disconnecting the cables from chargers. A poor connection can cause an electrical arc, which can result in an explosion.
4. Remove the battery vent caps before charging, and make sure that the electrolyte does not splash out as a result of charging too quickly.
5. Check literature supplied by battery manufacturer, and follow warnings or cautions outlined.

The converter is used to switch 120V electricity from an external supply, or from the generator, to 12 Volt electricity to power interior lights and 12 Volt accessories. The converter requires no maintenance under normal circumstances.

If the converter does not have a 120V supply to convert to 12 Volt, it automatically switches the batteries into the electrical circuit to power 12 Volt functions. When reconnected to a 120V supply, it will again operate from this power source.

The converter will run warm and this is normal. If, however, it gets too hot, it will turn itself off. After it cools down, it will come back on. In most cases, when this happens it is because something has been put around or too near the converter preventing it from receiving adequate ventilation. Make sure not to put anything near the converter that could obstruct ventilation.

A slight hum during operation is also normal for the converter, if you do not have 12 Volt power and no hum, check to see if 120 volt power to the converter has been interrupted.

Even with GFCI protection, persons with severe heart or other health problems may still be seriously affected by an electrical shock. The GFCI outlet is not a substitute for good electrical safety. It DOES NOT protect against contact of the hot and neutral wire at the same time.



The 120 volt outlet in the kitchen and/or bath and outside recepts are equipped with a protective circuit interrupter. The ground fault circuit interrupter (GFCI), is designed to break the flow of current to the protected outlet when an imbalance of current is detected. Imbalances include electrical leakage in an appliance such as a shaver or hair dryer that have developed a weak spot in electrical insulation. The possibility of electrocution exists when using a faulty appliance, while at the same time being in contact with an electrical ground such as water, plumbing, or the earth. If an imbalance is detected, the GFCI will trip and shut off power to the outlet.

The GFCI also does not protect against short circuits or system overloads. Circuit breakers in the main panel which supply power to the circuit, will trip if either of these conditions exist.

Battery Charging

POWER CONVERTER



GROUND FAULT CIRCUIT INTERRUPTER

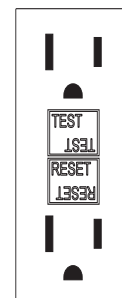

The GFCI receptacle should be tested initially when the motor home is purchased, and at least monthly thereafter.

To test the circuit, use the following procedure:

1. Make sure power is on to the circuit. A test light or 120 volt lamp will work.
2. Push the test button.
3. The red reset button should pop out.
4. All power should be interrupted to outlets protected by the GFCI.
5. Verify by plugging in a light at these outlets, and pushing in the reset button.

If the red reset button does not pop out after pushing the test button, or GFCI circuit continues to trip, or if the power is not interrupted to the test light, immediately turn off power at the circuit breaker panel and have a qualified electrician check it out.



Note: The GFCI does not protect any circuit other than the one to which it is connected.

12 VOLT SYSTEM FUSES Interior

A 12 Volt DC distribution panel is located next to the 120 Volt circuit breakers. The panel contains circuits with replaceable fuses for protection of motor home 12 Volt lines. If any line is shorted, the fuse will “blow”. Replace the fuse with the same size fuse. DO NOT replace with a larger fuse than indicated.

If this action does not solve the problem, there may be a “short” somewhere along the 12 Volt line, or at a non-fused 12 Volt component on the line. Check the 12 Volt line and any components along the line. Locate the “short” and take necessary steps to repair it. If you cannot locate the problem, have a qualified electrician check it out.

It is a good idea to keep additional fuses on hand in the motor home. Replacement fuses are available at filling stations, hardware stores, or automotive supply stores. Remember that the replacement fuse must be the same amperage rating as the original.

Your motor home chassis is equipped with an automotive 12 Volt fuse panel located below the dash near the steering column and/or under the hood. You should refer to the chassis owner’s manual for details on these fuses.

Automotive

The Class A motor home also has a 12 Volt fuse panel, electrical distribution box, located on the fire wall under the hood. These fuses protect the automotive features which are installed by Thor Motor Coach. There is a complete breakdown on the various fuses printed on the backside of this fuse panel cover.

CIRCUIT BREAKERS

The 120 Volt system is protected by circuit breakers which automatically shut the circuit off if the circuit load is too heavy, or a short circuit occurs. If a circuit breaker has been tripped, do not reset the breaker until the cause of the problem is identified and corrected.

The generator also has one or two AC circuit breakers, and a DC fuse on the generator control panel. If an interruption in generator operations occurs, check to see if any of these have been tripped. Consult the manuals provided with the generator before attempting maintenance on the generator.

 **Note:** Some electrical appliances may have their own circuit breakers. If there is an interruption in electrical service of an appliance, consult the manual for that appliance to determine what action to take.

 **Note:** Please use this information as a guide. Check your motor home for the sticker with the exact call outs.

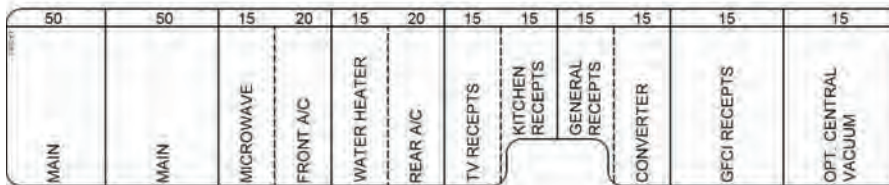

NO	GA.	COLOR	ATC FUSE	POWER TO
1	14	RED	15 AMP	WATER PUMP
2	14	GRAY	15 AMP	DRIVERSIDE
3	14	VIOLET	15 AMP	PASSENGER SIDE
4	14	BLUE	15 AMP	REAR
5	14	ORANGE	15 AMP	APPLIANCES
6	18	ORANGE	5 AMP	MONITOR/LP & CD
7	12	BROWN	20 AMP	CEILING LIGHTS
8	14	YELLOW	15 AMP	MISC
9	12/14	PINK	15 AMP	AWNING
10	14	BLACK	15 AMP	MISC. LIGHTS
11	14	TAN	15 AMP	POWER POINT
12	12/14	GREEN	15 AMP	REAR AWNING

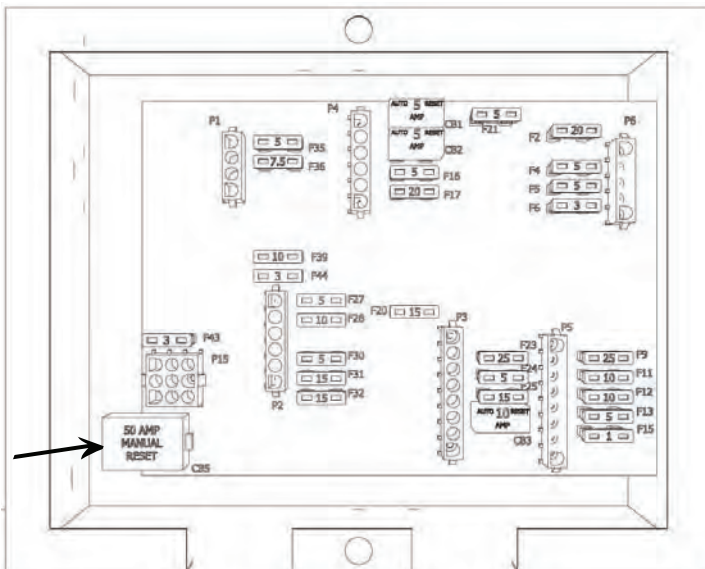

- P1-1 AUX START SWITCH
- P1-2 F35 RADIO
- P1-3 F36 ANTENNA BOOST
- P1-4 F39 RADIO MEMORY
- P2-1 F27 SOLAR PANEL
- P2-2 F28 O/S RADIO MEM
- P2-4 F30 OUTSIDE RADIO
- P2-5 F31 CARGO LIGHTS
- PS-6 F32 CARGO LIGHTS
- P3-1 F21 STEPS/AWNING
- P3-2 F20 FOG LIGHTS
- P3-4 F24 STEP SWITCH
- P3-5 F25 DOCK LIGHTS
- P3-6 CB3 DRIVER SEAT

SYSTEM PANELS 110V For Units With 50 Amp Service

110V For Units With 30 Amp Service And No Electric Water Heater

Converter Fuse Panel

BCC Fuse Panel

- P4-1 CB1 DRIVER SHADE
- P4-2 CB2 PASS SHADE
- P4-3 F16 MAP LIGHTS
- P4-4 F17 POWER POINT
- P4-6 FOG LIGHT RELAY
- P5-1 ACCESSORY RELAY
- P5-2 F9 HVAC BLOWER
- P5-3 F11 DASH FANS
- P5-4 F12 MIRROR HEAT
- P5-5 F13 JACKS POWER
- P5-6 F15 MIRRORS
- P6-1 F2 SPARE
- P6-2 F4 JACKS DOWN
- P6-3 F5 TV CUTOFF
- P6-4 F6 REAR VISION
- P6-5 IGNITION RELAY

 **Note:**

CHASSIS ALTERNATOR

Should you lose 12 Volt power inside your Class A gas motor home, there is a 50 Amp Reset Button in the Battery Control Center, located under the hood. Remove cover from the black box to access.



Note: On a Class C gas motor home there is a 50 amp reset button located behind the converter.

The automotive chassis 12 volt system alternator supplies power to both the automotive systems as well as any auxiliary battery if equipped, and directly to the motor home living quarters while the vehicle's motor is running.

The alternator compensates for electrical usage in the vehicle, the power drawn by the appliances, lights, fans and other 12 volt powered items as well as the charging of the automotive and auxiliary batteries.

If the alternator isn't keeping pace with the draw on the unit's electrical system, while driving down the road, it means you're working in a negative mode: more power is being used than the unit is putting out.

This means that you are taking power out of the batteries. If you draw too much power from the batteries there may not be enough power left in the battery to start the motor home or run any of the appliances when you stop for a break or for the night.

The alternator will charge at a higher rate right after the vehicle's been started, replacing the power used to start the vehicle, but the charging should quickly go back to "normal" and hold its own even when you turn on lights or appliances.

When stopped at a campsite that allows you use of the shoreline, the 120 volt electrical system will recharge your auxiliary battery.

Under heavy usage in warm weather, check the fluid level of those batteries that require attention to fluids quite often. Low battery fluid level is very harmful to the battery's longevity.

If the alternator shows a discharge while the motor is running, turn off appliances and lights to see if a charge comes on or if the alternator indicates "neutral". Then apply a drain on the system to see if a discharge returns. If a discharge persists, contact your dealer.

GENERATOR



DANGER

CARBON MONOXIDE IS POISONOUS AND CAN CAUSE UNCONSCIOUSNESS AND DEATH.



DANGER

TO AVOID EXHAUST GAS ENTRY INTO THE MOTOR HOME, KEEP WINDOWS CLOSED WHEN THE CHASSIS OR GENERATOR ENGINES ARE RUNNING.



Note: Make sure to read and understand the generator owner's manual before operating the generator. Observe all operating instructions and warnings as well as all recommended maintenance schedules and procedures.

The onboard generator allows the motor home to be fully self-contained. It provides access to 120 Volt A/C when shore power is unavailable, but keep in mind that when in use the generator exhausts deadly carbon monoxide gas! NEVER sleep in the motor home with the generator running! Before you start and use the generator inspect the exhaust system. Do not use the generator if the exhaust system is damaged. Test

the carbon monoxide detector every time you use the motor home. Know what the symptoms of carbon monoxide poisoning are:

- **Dizziness** • **Vomiting** • **Nausea** • **Muscular twitching** • **Intense headache**
- **Throbbing in the temples** • **Weakness and sleepiness**
- **Inability to think coherently**

If you or anyone else experience any of these symptoms get to fresh air immediately. Shut the generator down and do not operate it until it has been inspected and repaired by a professional. If the symptoms persist seek medical attention!

1. **DO NOT** operate the generator while sleeping. You would not be aware of exhaust entering the motor home, or alert to symptoms of carbon monoxide poisoning.
2. **NEVER** store anything in the generator compartment. Always keep the compartment clean and dry.
3. **DO NOT** operate the generator in an enclosed building or in a partly enclosed area such as a garage.
4. **REVIEW** the safety precautions for fuel and exhaust fumes elsewhere in this manual.
5. **DO NOT** operate the generator when the motor home is parked in high grass or brush. Heat from the exhaust could cause a fire in dry conditions.
6. **NEVER** operate the chassis or generator engine, or the engine of any vehicle, longer than necessary when the vehicle is parked.
7. **DO NOT** simultaneously operate generator and a ventilator which could result in the entry of exhaust gas.
8. When parked, position the motor home so that the wind will carry the exhaust away from the motor home. **DO NOT** open nearby windows, ventilators, or doors into the passenger compartment, particularly those which can be “down wind”, even part of the time.
9. **DO NOT** operate the generator when parked in close proximity to vegetation, snow, buildings, vehicles, or any other object which could deflect the exhaust under or into the motor home.
10. **DO NOT** touch the generator when running, or immediately after shutting off. Heat from the generator can cause burns. Allow the generator to cool before attempting maintenance or service.

The generator draws fuel from the motor home chassis fuel tank. The fuel supply line for the generator is placed higher in the fuel tank than that of the fuel supply line for the chassis engine, this prevents the generator from draining all the fuel from the fuel tank.



Note: Some models may require you to plug the 30 amp shoreline into the generator outlet provided in the shoreline storage compartment.

To start the generator locate the generator start switch, which is located at one of the following locations:

- Generator Control Panel
- Kitchen Base Cabinet
- Remote Dash Switch



Water Systems

The motor home plumbing system has the dual ability to be self-contained with on-board storage, or use facilities provided by an external pressurized source. In either case, the components of the system operate like those in your home. Components of the plumbing system consist of strong, lightweight, corrosion-resistant materials that provide long life, and easy cleaning. By following the instructions outlined here, you can expect efficient operation with a minimum of maintenance.

Motor home plumbing can be divided into two separate systems. The fresh water system consists of those items which are used to deliver water for your use, while the waste water system is made up of the drains and tanks which store and remove water that has been used.

Water provided from outside the motor home is pressurized by the system from which it is delivered. When you connect your motor home to an outside source, the fresh water tank and the water pump are kept separate from the remainder of the system by in-line check valves.

To connect the motor home to an outside source of water:

1. Remove the cap from the fresh water inlet on the side of the motor home and attach one end of the fresh water hose to the outside source of water.
2. Connect the other end of the hose to the motor home city water inlet.
3. Turn the outside source of water ON and open the various faucets in the motor home gradually to clear the air from the lines. Close the faucets when the water flows freely.

 **Note:** Do not turn the water pump on when using water from an external supply.

To disconnect from the outside source of supply:

1. Shut off the outside source of water and disconnect the hose from the valve and vehicle inlet.
2. Re-reel the hose and reinstall the cap on the motor home inlet.

Some water sources develop high water pressure, particularly in mountainous regions. These campgrounds or hookup locations may not have regulated water pressure, which could be considered excessive. High pressure is anything over 55 psi. Excessive pressure may cause leaks or damage to your water system. Water pressure regulators are available to protect the water system against high pressures. Check with your dealer for recommendations of water pressure regulators.

 **CAUTION**

When an outside source of water is unavailable, water can be drawn from the fresh water storage tank for use in the motor home. The tank is filled through a gravity controlled water fill spout on the side of the motor home.

To fill the fresh water tank:

1. Remove the water fill spout cap and fill directly to the tank.
2. Use a clean hose or bucket from a clean, safe source of water.
3. Be sure to replace the fill spout cap after the tank is filled.

FRESH WATER SYSTEM

External Hook-up



Fresh Water Tank With Gravity Fill





Note: Never leave the hose unattended while you are filling the fresh water tank.



Note: Water will overflow through the vent located at the top of the fresh water tank if the tank is filled beyond capacity.

When traveling, you may want to drain the tank, or keep the quantity of water in it to a minimum. This reduces the total weight of the motor home for travel. Make sure when draining the tank, that the water pump has been turned off. The fresh water tank drain valve is located below and near the fresh water fill spout. Water in the tank can be drained by turning the drain cock perpendicular to the motor home body. To close the valve, turn the lever parallel to the motor home body.



Note: When trying to drain the entire on-board fresh water system, make sure to open faucets, water heater drain, and system low point drains to remove all fresh water from the system.

Fresh Water Tank Without Gravity Fill

When an outside source of water is unavailable, water can be drawn from the fresh water storage tank for use in the motor home.

To fill a fresh water tank:

1. Attach a potable water hose to the inlet inside the water systems panel area, and an outside water supply.
2. Turn the lever on the by-pass valve to the fresh tank position and begin filling.
3. When the tank is full turn off the water supply. View reading on the monitor panel.



Note: Never leave the hose unattended while you are filling the fresh water tank.



Note: There is an overflow vent located at the top of the fresh water tank. If the tank is filled beyond capacity water will flow out through this vent onto the ground.



Note: Always fill the tank with clean potable water from a known safe source. Make sure to close the fill spout when the tank is filled.

Water Pump

When using water from the fresh water tank, the system must be pressurized. A self-priming 12V DC pump is provided to handle this function. A pump ON/OFF switch is located on the monitor panel.

When initially starting up the self contained water system, follow this procedure:

1. Make sure the tank is filled with water.
2. Open all the faucets in the motor home, both hot and cold.
3. Place the pump control switch in the ON position.
4. Allow time for the hot water tank to fill. Shut off each faucet as the flow becomes steady and free of air. When the last faucet is shut off, the pump should also shut off.
5. The system is now ready for use.



Note: When filling the system, you may want to add additional water to the tank to replace the water used when filling the hot water tank and water lines.

The fresh water storage tank supplies potable water to all fixtures within your motorhome by means of a 12 Volt water pump. This pump is located close to the storage tank and is equipped with a check valve that ensures directional flow away from the tank. The pump has an on/off switch, which is located on the monitor panel, bathroom, or termination compartment. The pump will automatically build up pressure and maintain that pressure when turned on. The pump should be turned off when the fresh water tank is empty or when the motorhome will not be in use. Continued operation with a dry tank may damage the pump. Your pump has a filter on the inlet side. This filter should be cleaned after each tankful of water for the first few uses. To remove the cover press in firmly and twist counterclockwise about one eighth turn. Pull the screen out of the bowl and rinse clean. Reassemble in the reverse fashion. For more information check your water pump Owner's Manual located in your Owner's Information Kit.

The low point drains are located in the water lines on the floor of the motor home except the Windsport brand motor home. Specific locations along the water lines will vary depending on the model of your motor home. The low point drains for the Windsport model are the outside shower which is located in an exterior compartment, below the floor.

You should sanitize and disinfect the fresh water system upon delivery of the unit and at least once per year or whenever the motorhome is unused for prolonged periods of time. This will help keep your water system fresh and discourage the growth of viral and bacterial contamination, which may be contained in your water supply. Use a chlorine and fresh water rinse as follows:

1. Drain the fresh water tank by opening the drain valve. All of the faucets should be in the closed or off position.
2. Prepare a solution of 1/4 cup household liquid chlorine bleach (5% sodium hypochlorite) to one gallon of water for every 15 gallons of tank capacity. Do not pour bleach straight into tank. Bleach must be diluted in water prior to filling.

Example: Add four 2/3 gallons solution to a 70 gallon tank.
Add five 1/3 gallons solution to a 80 gallon tank.
Add six 1 gallon solution to a 90 gallon tank.
Add six 2/3 gallons solution to a 100 gallon tank.

This mixture puts a 50 PPM (parts per million) residual chlorine concentration in the motorhome's water tank. This will act as quick-kill dosage for some harmful bacteria, viruses, and slime-forming organisms. Concentrations higher than 50 PPM may damage water lines and/or tank.

3. Close all faucets and drains, and fill the fresh water tank with the rinse solution through the potable water fill.
4. Turn on the pump switch and circulate the rinse solution throughout the entire system.
5. Once the rinse solution has been circulated through the entire system, fill the fresh water tank until it is full.
6. Close all faucets and drains and let the system sit for approximately three (3)

LOW POINT DRAINS

SANITIZING THE SYSTEM

hours.

7. Drain the entire system.
8. Flush the complete system with fresh water until chlorine odor disappears.
9. Finally, close all drains and fill the fresh water tank as you normally would. Make sure the water heater has water in it prior to igniting.

⚠ WARNING Chlorine is poisonous. Recap bottle and clean any appliances used with soap and water.

MONITOR PANEL



The monitor panel allows you to quickly check the levels in the fresh water and waste water tanks. Electrical sensors at various points on the tanks send signals to the monitor panel. To check fluid levels, press and hold the test switch designated for the tanks, and read the level indicators on the panel. The indicator is proportioned in thirds with each light being lit up to the level that the tank contains.

Sometimes, residue on the sides of a tank, or water with a low mineral content will give a false reading. Check the levels occasionally when you are sure of a tank's contents to double check the accuracy of the monitor panel.

Tank Capacities

The monitor panel allows you to quickly check the levels in the fresh water and waste water tanks. Electrical sensors at various points on the tanks send signals to the monitor panel. To check fluid levels, press and hold the test switch designated for the tanks, and read the level indicators on the panel. The indicator is proportioned in thirds with each indicator light illuminating to the level that the tank contains. Indicator lights and their meanings:

Inaccurate Holding Tank Level Readings

The accuracy of two wire holding tank monitoring systems can be adversely affected by dirty tanks or unusual mineral content in the water. These conditions can cause the monitoring system to have oversensitive (reads higher than actual level) or under sensitive (reads lower than actual level) readings.

Oversensitive Readings

Oversensitive readings can occur as a result of scum build up on the tank walls, or abnormally high mineral content in the water. In these situations, the monitoring system indicates higher levels than are actually present in the holding tank. Certain cleaning products and food by-products can build up on the inside walls of the holding tanks, producing a layer of scum that can cause the monitoring system to read higher than the actual level. To correct this problem, the holding tanks should be cleaned periodically (consult dealer for cleaning instructions).

Undersensitive Readings

Under sensitive readings can occur if the mineral content of the water is abnormally low. In this case, the monitoring system indicates lower levels than are actually present in the holding tank. This problem can be corrected by moving the ground probe closer to the other probes.

WASTE WATER SYSTEM

The waste water system is comprised of dual holding tanks with individual termination valves. The holding (solid waste) tank as indicated on your monitor panel, collects all the waste material from the toilet. The gray water tank collects all of the liquid waste material from the sinks, drains, and showers. Both tanks are joined together after the termination valve to provide a single termination outlet for convenient dumping of waste materials. A flexible sewer hose (which is not provided) is required to make the connection between your unit's termination valve and the approved dump station inlet.

The drainage system is very similar to that of your home. The system is trapped and vented to prevent waste gases from entering your motorhome. The drain piping is

made of ABS material and is resistant to most chemicals. The “P” traps at the sinks, showers and tubs are available for use as clean-outs if necessary.

Your vehicle's holding tank compartments are heated by the furnace duct work. It will heat the tanks when the furnace is operating.

As mentioned previously, your holding tanks terminate together at one location for convenience in dumping your tanks. A twist-on cap is located at the terminal outlet to help prevent leakage of materials.

The holding tanks are enclosed sewer systems, and must be drained into an approved dump station. Tanks should be thoroughly drained and rinsed to prevent any accumulation on the interior of the tanks.

⚠ CAUTION

1. Twist off the termination cap counterclockwise. Some liquid may be trapped between the valves.
2. Connect the sewer hose by turning it clockwise, making sure that the connection end levers are locked over the termination end.
3. Deposit the other end of the sewer hose into an approved dump station inlet.
4. Open the black termination valve first and drain.
5. Open the gray (smaller) tank valve to drain and flush out the hose.
6. Rinse the tanks and hose thoroughly with fresh water before disconnecting.
7. Close the termination valves.
8. Rinse the sewer hose with the faucet provided in the termination compartment.
9. Replace the sewer hose to the storage location.
10. Replace the termination cap on the outlet, making sure that it is secured and locked.

The most common holding tank problem is blocking the drain lines, which can be minimized by following a few simple suggestions:

- Always use plenty of water when flushing.
- Do not put facial tissue, paper, baby wipes, or sanitary napkins into your holding tanks.
- Do not put solid objects into the tank which could puncture or scratch your tanks.
- Do not leave the termination valves in the open position or open them prior to having the sewer hose connected. Do not remove the termination cap with the termination valves in the open position.
- You may wish to add an approved deodorant chemical, approved for your sewer system, to aid in the breakdown of solid wastes as well as making your system more pleasant to use.
- Prior to dumping, make sure your tank is at least 1/3 full.

HEATED HOLDING TANKS

DUMPING THE HOLDING TANKS

HOW TO PREVENT BLOCKAGE OF DRAIN LINES

TERMINATION COMPARTMENT COMPONENTS

- Fill and cover the bottom of the tank with water after dumping is complete and leave the water in the tank.
- Use only approved, biodegradable, toilet tissue designed specifically for motorhome systems.

The termination compartment has many operations. Please note that because of the various configurations of each individual motorhome, the items listed below may or may not pertain to your unit. Listed below are the fixture call outs and functions:

1. Exterior shower head. For washing animals, hands, sewer hose, or any exterior cleaning job.
2. Termination valve handle. To open, grab handle, and pull outward. Make sure that the drain hose is connected.
3. Termination cap. Remove this to install the sewer hose. Be sure that the termination valves are closed before removing this cap.
4. Sewer holding tank flush attachment. Attach the city pressure hose and allow the water to flow for three minutes. Be sure to open the termination valves and have the sewer hose attached and draining into an approved waste disposal system.
5. Hatch cover. Open this and pass your city pressure hose through. Close with hose passing through small opening in the cover.
6. Exterior faucet. For mixing the water temperature for the exterior shower head.

TOILET

The toilet installed in the motor home is connected to the pressurized fresh water system. The two most common style of toilets use either a foot pedal or hand lever to flush and add water to the bowl.

ADD WATER

FLUSH

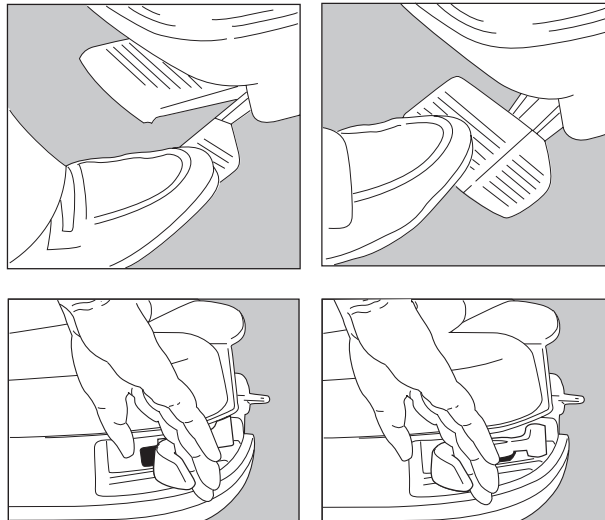

Hand Lever Style

To flush the hand lever style, pull the lever forward (clockwise) until rinse clears the bowl. Be sure to release the lever slowly. Movement of the flush lever opens the waste valve and allows the water to pass into the holding tank.

To add water to the bowl, pull the lever forward (clockwise) approximately half way. This will open the water valve and leave the flush lever closed.

To flush the foot pedal style, depress the large pedal on the left hand side until rinse clears the bowl. Be sure to release the lever slowly. Movement of the flush lever opens the waste valve and allows the water to pass into the holding tank.

To add water to the bowl, depress the small pedal on the right hand side. This will open the water valve and leave the flush lever closed.

 **Note:** Unnecessary frequent flushing of the stool will quickly deplete your fresh water supply and fill your holding tank. If the black water tank becomes full, you will no longer be able to flush the stool until the tank can be drained.

 **Note:** Follow the toilet manufacturer's recommendations supplied with the toilet for cleaning and maintenance. If you have a toilet that differs from the description given here, make sure to follow the manufacturer's advice for operation.

Foot Pedal Style



PROPANE GAS IS HIGHLY VOLATILE AND EXTREMELY EXPLOSIVE. DO NOT USE MATCHES OR A FLAME TO TEST FOR LEAKS. USE ONLY APPROVED PROPANE GAS LEAK TESTING SOLUTIONS FOR LEAK DETECTION. Unapproved solutions can damage copper tubing and brass fittings. Never attempt to adjust propane gas regulators. Only qualified personnel should perform any maintenance or repair to the propane gas system.

⚠ DANGER

The propane gas system furnishes the fuel for cooking, heating, and hot water. Propane gas can also be used as an alternate energy source for refrigeration. Propane is a clean, efficient, safe form of energy when proper handling and safety precautions are observed.

The Propane Gas system is designed to accept either Propane or Butane. However, since Butane vaporizes at about 32°F, it can only be used in areas where you can be sure of higher temperatures. Propane vaporizes at approximately -40°F. There are blends of Propane and Butane available, which will vary in the temperature at which it vaporizes. When filling the tank, select a Propane Gas that has a boiling point about 40° lower than temperatures you expect to travel in. Consult with your dealer, or local Propane Gas supplier about what you should be using.

The gas is stored under extreme pressure in the tank, with space in the tank to allow for expansion into vapor. This vapor is reduced in pressure by passing through a regulator. This reduction in pressure is a two step process which assures consistent pressure for use, regardless of outside temperatures, weather, or altitude.

 **Note:** For detailed information regarding propane gas and its use, consult a qualified propane service representative.

MAKE SURE THAT THE TANK IS NOT FILLED BEYOND THE 80% LIQUID LEVEL. Even though the tank is equipped with an automatic 80% shut-off which prevents over-filling beyond 80% tank capacity, it is a good idea to have the supplier monitor the 20% liquid gauge, and stop the filling process if liquid does appear. If the tank has been over-filled, make sure the propane supplier bleeds out the excess. Over-filling the propane gas container does not allow for the necessary 20% vapor expansion space and may result in an uncontrolled gas flow which can cause a fire or explosion.

⚠ WARNING

 **Note:** Make sure the tank service valve is accessible at all times. In an emergency, it may be necessary to shut off the valve quickly.

⚠ DANGER

1. Before entering the propane bulk plant or service station, make sure all pilot lights are extinguished. Shut off gas to all appliances by first turning off each appliance, then close the propane gas main shut-off valve.
2. Extinguish open flames and smoking materials.
3. Never remove the propane gas tank from the motor home. Always drive the motor home to the gas supplier to fill.
4. Have the supplier connect the fill nozzle to the tank fill connection.
5. Always remember to close the supply valve and open the 20% liquid level valve.
6. Never use a wrench to close the service or the 20% liquid level valve. If when closing by hand, leaking occurs, have the valve repaired or replaced.

PROPANE GAS TANK



Filling the Tank

PROPANE REGULATOR

7. Drive at least one mile from the propane gas supplier before relighting pilot lights or appliances. This will allow any minimal leakage which occurred while filling the tank to dissipate. DO NOT light pilot lights if you continue to smell propane gas. Shut off the Supply Valve. Allow the motor home to ventilate for 30 minutes. If you still detect propane odor, have the source of the leak located and repaired.

Never use any other tank than the one furnished with the motor home. If the tank must be replaced, check with your dealer for correct tank specifications and replacement procedure.

⚠ WARNING NEVER ALTER THE POSITIONING OF THE REGULATOR. PROPANE GAS REGULATORS MUST ALWAYS BE INSTALLED WITH THE DIAPHRAGM VENT FACING DOWNWARD. ALSO MAKE SURE TO KEEP THE REGULATOR COVER IN PLACE TO MINIMIZE VENT BLOCKAGE WHICH COULD RESULT IN EXCESSIVE GAS PRESSURE CAUSING FIRE OR EXPLOSION. DO NOT RELY UPON BEING ABLE TO SMELL PROPANE GAS LEAKS, AS THE ODOR MAY NOT BE SUFFICIENTLY STRONG ENOUGH TO DETECT.

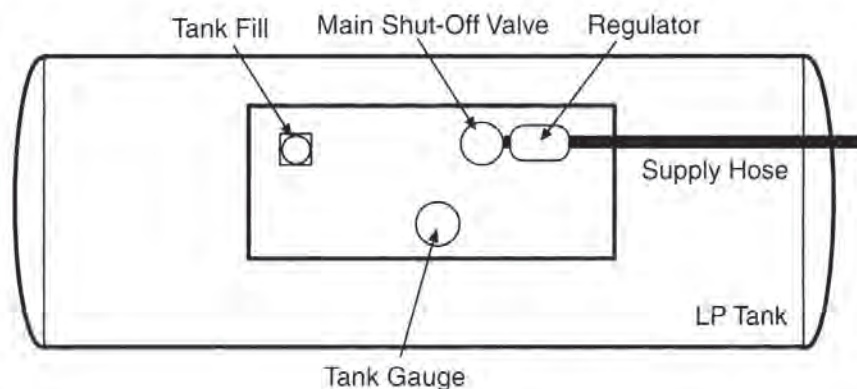

The regulator reduces the pressure of the propane gas vapor from the pressure in the tank, to the pressure required for use at the appliances. This reduction in pressure is performed by a two-stage regulator. Two regulators are used in the same body to reduce the pressure of the propane gas in the tank for use by the appliances in the motor home. The regulator seldom requires service, but it should always be protected from the elements and extremes of hot and cold.

The high pressure regulator (first stage) is used to reduce the pressure to approximately 10 to 13 PSI before sending it along to the low pressure regulator (second stage). This second stage regulator reduces the pressure further to 11 inches water column, or 6.35 ounces per square inch. The two stages regulator does not have to work as hard since the second stage receives consistent pressure rather than inlet pressure which varies. The result is an efficient safer system that helps to eliminate problems such as freeze up and pilot outage.

The regulator has been preset by the manufacturer of the regulator, and adjustment should not be necessary. If adjustment should be required, DO NOT attempt to adjust it yourself. Adjustment must be made with special equipment by a qualified propane gas service technician. Have the regulator checked annually, or whenever you suspect

a problem. The correct line pressure should be 6 ¼ oz. or 11 inches of water column.

Because air is required for proper operation of the regulator, it is very important that the regulator vent is kept clean and free of dirt and debris. This is why it is necessary to keep the vent facing downward and the regulator covered to protect it from contamination. A toothbrush can be used to clean the vent if it becomes clogged by foreign matter.

If you believe a regulator has been damaged or otherwise is not functioning, have it replaced by a qualified propane gas service representative.

During cold weather, it is important to keep ice from forming in the regulator, which will shut off the flow of propane gas to the appliances. Have the supplier add a hydrous methanol when filling the tank for use during cold weather. Regulator freeze-up can occur in any weather if there is moisture in the tank, or if the tank has been over-filled. Always use moisture-free propane gas, and make sure the tank has not been filled beyond 80% of capacity. If moisture has entered the tank, have the tank purged, or have hydrous methanol added by an authorized propane gas supplier.

The term regulator freeze-up is a misleading one. Regulators and propane gas do not freeze. However, the moisture that can be contained in the gas will freeze as the gas expands and cools passing through the regulator. This freezing of the moisture in the gas can build up and partially or totally block the passage of the gas through the regulator. Freezing can also occur when outside temperatures are low enough to contribute to the freezing of the moisture in the gas.

The source of the moisture is varied. It can occur at the refinery or gas bulk plant, in the rail cars used to transport the gas, or even within the motor home propane gas tank. Moisture in a propane gas tank can occur when a tank service valve is left open, allowing moist air to enter and become trapped.

A two-staged regulator helps to reduce the possibility of freeze-up because of its larger orifice size, and the fact that heat is transferred through the walls of two regulators instead of just one.

Take these steps to inhibit or prevent this from happening:

1. Make sure that the propane gas tank is free of moisture before refilling
2. DO NOT overfill the propane gas tank.
3. Make sure to keep the service valve on an empty tank closed.
4. If freezing has occurred, have your propane gas dealer purge the propane gas tank before refilling.
5. Add a hydrous methanol or other approved propane gas antifreeze or de-icing agent to the propane gas tank.
6. Keep the regulator covered at all times.



Note: **IF FREEZE-UP DOES OCCUR**, shut off the propane gas at the tank. A frozen regulator may permit propane gas to flow at high pressure, resulting in leaks at appliances or in the lines. If freeze-up does occur, NEVER attempt to thaw with an open flame. Once thawed, be sure to take the proper steps to prevent a reoccurrence. Have the system checked by your propane gas supplier if freeze-up continues.

Remember that as outside temperatures drop, the BTU value of the propane gas is lessened, since the colder liquid propane in the tanks requires the heat from the

Regulator Freeze-Up

PROPANE GAS HOSES PIPES TUBES AND FITTINGS

surrounding air to vaporize. This lowering of BTU value can significantly affect the performance of the system. You can help insure proper performance by keeping the propane gas tank as full as possible in cold weather, and reviewing the BTU/hr plates on propane gas appliances for proper propane management.

Although the hoses, pipes, tubes, and fittings used in the propane gas system are designed to withstand pressures far exceeding those of the propane system, because environment and time can both contribute to the deterioration of these components, they must be inspected for wear at regular intervals. Be sure to inspect the hose before each season and when having the tank refilled. Look for signs of deterioration such as cracks or loss of flexibility. When replacing the hose or other propane components, always replace them with components of the same type and rating. Check with your dealer regarding proper replacement components.

DO NOT STORE PROPANE GAS CONTAINERS INSIDE THE MOTOR HOME. PROPANE GAS CONTAINERS ARE EQUIPPED WITH SAFETY DEVICES WHICH RELIEVE EXCESSIVE PRESSURE BY DISCHARGING GAS TO THE ATMOSPHERE. FAILURE TO COMPLY COULD RESULT IN AN EXPLOSION RESULTING IN DEATH OR SERIOUS INJURY.



This vehicle is designed with a propane system to provide a safe and reliable fuel source for your range, furnace, water heater, and refrigerator. As with any flammable and volatile material, proper handling and precautions should be exercised at all times. The following warnings must be reviewed and adhered to for safe and trouble free operation.

PROPANE GAS SAFETY PRECAUTIONS

If you smell propane gas:

1. Extinguish any open flames, pilot lights and all smoking materials.
2. **DO NOT** touch any electrical switches.
3. Shut off the gas supply at the tank valve(s) or gas supply connection.
4. Open all doors and other ventilating openings. (**DO NOT USE THE RANGE HOOD**).
5. Leave the area until the odor clears.
6. Have the system checked by a trained professional before using again.

When performing any work or maintenance in the motor home, ensure that you do not puncture a gas line with a nail, screw, or drill bit.

Warning labels and decals are used throughout the motor home in locations where the potential for a dangerous situation is present. They have been installed not only because of the requirement to do so, but also as a constant reminder to occupants of the motor home to exercise proper caution when using or being around propane gas appliances and equipment. Make sure that you and your family understand and follow all of them. Never remove these warning labels and decals. If one should be lost, it should be replaced as soon as possible.

Care and Maintenance

Periodic maintenance and cleaning of your recreational vehicle is necessary to retain the dependability, safety, and appearance that will provide you with many miles of trouble free operation, as well as protecting your investment.

Make sure you read and follow all the maintenance tips and schedules that appear not only in this manual, which for your convenience we have provided for you, but also in the manuals provided by the chassis manufacturer and various component manufacturers. Keep good records of maintenance functions performed, and make sure you perform all owner obligations as may be required to keep your warranty in force.

It is also important to note that operating conditions will affect service timetables. Driving in extreme conditions such as heavy dust, continuous short trips, or start and stop heavy traffic means that service durations will be shortened. Discuss service timetables with both your dealer and chassis service representative. Preventative maintenance will pay for itself many times over by catching or preventing problems before they occur. Many repair costs are greatly increased due to the fact that a small problem can begin to affect other parts and systems of the motorhome if left unattended.

If a situation arises involving maintenance or cleaning activity for which you are not sure of the proper procedure, do not hesitate to contact your dealer, or chassis service representative for information.

 **Note:** Performing periodic maintenance is not covered under the Thor Motor Coach Limited Warranty.

 **Note:** The following instructions are guidelines for the care and maintenance of your motorhome. Please refer back to the products Owner's Manual for more information on the care and maintenance of that product.

The chassis batteries are 12 Volt automotive batteries, which provide power for all vehicle requirements. Have these batteries serviced when servicing other vehicle systems.

Auxiliary batteries (house batteries) for motorhomes are dual auxiliary 6 Volt batteries to provide living area power requirements. Have these batteries serviced when servicing other vehicle systems.

When operating properly, the motorhome alternator will be able to handle normal vehicle driving requirements and also recharge the batteries in a reasonable time when on the road.

- Every 30 days check battery mounting. Tighten battery cables and clean terminals if necessary.
- Check and recharge as necessary. Keep connections clean and covered with a light coat of grease.
- Check the water level weekly and add distilled water if necessary.

 **Note:** Vehicles left in storage for extended periods of time require further provisions to maintain a proper state of charge of the vehicle batteries. Parasitic loads (drains) from the radio, clock, powertrain control module, courtesy lights or other accessories will discharge a battery if the vehicle is not used for an extended period of time. A discharged battery can actually freeze in temperatures of 32 degrees F (32°F), resulting in permanent damage to the battery. Batteries may also be permanently damaged if allowed to stand for long periods of time in a state of discharge.

GENERAL INFORMATION

BATTERIES



Chassis Battery



Auxiliary Battery

To alleviate battery discharge, during periods of storage of two weeks or less, disconnect the battery by pressing the battery disconnect switch located by the entry steps to the store mode. For extended periods of time the battery should be disconnected by removing the negative cable from the battery.

A disconnected battery may also self-discharge, especially in high ambient temperatures, therefore every disconnected battery should be checked periodically and recharged if necessary.

WATER SYSTEM

Check all hoses, fittings, and connections regularly for leaks and signs of wear. Make sure to keep the system sanitized, and take care to winterize during cold weather (see instructions elsewhere in this manual). Do not allow water to remain in system for extended periods or after a trip.

WASTE WATER SYSTEM



The drainage system, including the tanks and associated drain piping should be periodically inspected for loose fittings from vibrations. Any deterioration of the sealant around joints and fittings should be repaired immediately.

Check the operation of the termination valves. If they pull or close with effort, lubricate the shaft and slide valve with spray silicone. Termination valves that leak should be repaired or replaced as soon as possible.

Sometimes, a buildup of paper or other material in the inside groove of the termination valve can obstruct the valve and cause it to seat improperly. If you suspect that this is occurring, the valve can be removed from the drainage line by removing the four screws that hold it in place and sliding it out. The valve groove may then be cleaned out with a screwdriver or similar tool. Replace the valve in the line and reinstall the screws to secure it in place.

FRESH WATER SYSTEM



It is recommended that fresh water not be left in the storage tank for long periods of time. The water should be drained when the unit is being stored or not in use. Drains are located in a variety of compartments. To drain the tank and lines, simply open the low point drains and allow water to run out. After water has drained, close the valves to prevent pests from entering the system. Check all hoses, fittings, and connections regularly for leaks and signs of wear. Make sure to keep the system sanitized, and take care to winterize during cold weather.

ELECTRICAL SYSTEM

The electrical system requires minimal maintenance under normal circumstances. Most electrical maintenance in the recreational vehicle involves the chassis and auxiliary batteries. Keeping the batteries properly maintained will help to eliminate many frustrating electrical problems.

GENERATOR POWER SYSTEM

The generator is another area in which simple preventive maintenance can head off problems before they happen. Read the manual supplied with the generator in the Owner's Information Kit for the care and maintenance required on a regular basis.

If you experience electrical problems with your recreational vehicle, make sure to have it checked by an authorized Thor Motor Coach dealer or a qualified RV technician.

Generator power plant service, recommended by the generator manufacturer, should be performed at an authorized service center. Routine or emergency service, such as adding oil, changing filters, or replacing spark plugs, could be accomplished at an auto service center, but must be done in accordance with the service instructions specified by the generator manufacturer. Refer to the Generator Owner's Manual for further information.

All service procedures should be performed only by a certified propane service technician.

⚠ CAUTION

PROPANE SYSTEM

The propane system should be checked regularly for leaks and road damage. Follow the lines, looking for kinks or flattened spots that may have occurred during travel or maintenance on the recreational vehicle. A qualified propane service technician using proper equipment should check the entire system annually or whenever you suspect a problem.

The line pressure for propane appliances should be checked at least every six months. Most propane suppliers have this equipment to do the test for you.

Insects can build nests in the burners of the various appliances and equipment. The burner and burner orifice of the propane appliances should be cleaned out by an authorized dealer or repair facility anytime circumstances or conditions warrant, but no less frequently than on an annual basis.

Some components of the recreational vehicle are constructed of strong, lightweight ABS plastic. Sometimes, it may be necessary to remove stains, or generally clean. A mild solution of soap and water will clean many stains, and should be used initially. Tougher stains may require stronger cleaners, but be sure to read the label to determine if the product is recommended for use on plastics. Avoid abrasive cleansers (even the liquid and cream types), alcohol based products, and solvents such as acetone and MEK. Gasoline and kerosene should not be used because of the damaging effect they have on the plastic surface, as well as the fire hazard they present. Often the damage caused by solvents, alcohol, and oil based products may not be immediately noticeable, but the plastic is made weaker, and thus more prone to stress cracking.

ABS PLASTIC PARTS

AVOID ABRASIVE CLEANSERS (even the liquid and cream types), alcohol based products, and solvents such as acetone and MEK. Gasoline and kerosene should not be used because of the damaging effect they have on the plastic surface, as well as the fire hazard they present. Often the damage caused by solvents, alcohol, citrus based and oil based products may not be immediately noticeable, but the plastic is made weaker, and prone to stress cracking.

⚠ CAUTION

The front suspension and steering system of this vehicle was factory aligned using highly accurate equipment prior to delivery to the dealership. However, we recommend that alignment be checked and if necessary, adjusted after you have fully loaded the motorhome according to your personal needs. Thereafter, the alignment should be inspected annually to help prevent uneven tire wear. All alignments and incurred costs are the responsibility of the retail owner.

ALIGNMENT

Check that the top and bottom bracket screws are tight at the start of each camping season.

1. Lubricate the rafter arms and support arms using paraffin wax or silicone spray. Also lubricate the threads on the knobs.
2. Periodically clean the awning fabric as follows: For a vinyl material use a mixture of 1/4 cup of dish soap and 1/4 cup of bleach mixed with 5 gallons of warm water. Liberally apply this mixture on the top of the fabric, then roll the awning up for 5 minutes. This will apply the mixture to the bottom as well. Roll the awning back out and hose off with fresh water. Repeat if necessary. Allow to dry before rolling back up. Avoid the use of caustic household cleaners, mildew removers or hard bristle brushes. Do not scrub!

AWNING

For an acrylic material, periodically hose off the fabric with water then let dry completely before rolling it back up. The acrylic material is water repellent, not water proof. The fabric is pretreated with a water retardant finish. Mildew cannot form on the fabric, but rather will form on dirt or dust on the fabric. The key is to keep the fabric clean. Do not scrub!

Whenever the awning is wet while rolled up, as soon as conditions allow, roll it out, hose it off and let it dry completely before rolling it back up again.

If you get water streaking or seeping behind the awning rail, inspect the rail for loose screws or peeled sealant. Always make sure the awning is extended high enough before opening the entry door.

Lower one end of the awning for proper water run off and to avoid water pooling and possible damage to the awning.

Refer to your awning users guide for complete instructions on the care and maintenance of your awning.

CAUTION

Failure to lower one side of the awning could result in damage to the awning fabric and/or hardware due to the weight of water pooling.

CHASSIS

Refer to your Chassis Operator's Manual for information on chassis service recommendations.

Have the engine coolant and engine oil level checked each time when refueling.



Note: Proper engine servicing and record of servicing may be mandatory to ensure chassis warranty protection. Follow the manufacturer's instructions on periodic maintenance checks.

Make sure to check the operation of all exterior lights often. Check headlights, clearance, turn signal, brake, and backup lights to make sure they are working correctly. Remember to check any towed vehicle or trailer lights also. Replace burned out bulbs as soon as possible.

EXTERIOR LIGHTS

Condensation occurs when the air inside the lamp assembly, through atmospheric changes, reaches the "dew point". When this takes place, the moisture in the air within the lamp assembly condenses, creating a fine mist or white fog on the inside surface of the lamp lens or chrome reflector surfaces. The head lamps are designed to remove accumulated moisture vapor by expelling it through a vent system as the light warms up. The vent system operates at all times, however it is most effective when the lamps are on and the vehicle is in motion. Since most motor homes are parked for long periods of time, they have a greater chance of condensation build-up.



Note: Check head lamp regularly for condensed water drops. This should be done daily in high humidity areas.

If small drops of condensed water are noted, drive the motor home with head lamps "ON" or just turn "ON" the head lamps. This will evaporate the condensed water drops and will avoid water being accumulated. Depending on the size, shape and location of the lamp on the motor home, and the atmospheric conditions occurring, the amount of time required to clear the lamp may vary.

Cleaning is the most effective maintenance that you can perform on your lights, dirt and road grime build up can cut light output by 40% or more.

When cleaning your head lamps, please observe the following: do not rub them dry, and never use abrasives or strong solvents. Remove dirt and contamination, such as insects, by soaking with shampoo and then rinsing with plenty of water. Always use a de-icer spray to remove accumulated ice and snow; never use a scraper.

Check the head lamp vent tubes, this will be a small rubber hose or plastic cap located on the back of the light, make sure that they are free of dirt and the rubber is not cracked or dried out. If the vent tubes are clogged, cracked or dried out the vent system will not work correctly, allowing condensation to build up in the lamp. If the tube is cracked or dried out please replace it. Replacement parts can be acquired from your motor home Dealer.

Head lamp seals should not be directly sprayed with high pressure (home or industrial) wash systems. Damage to the seal can occur, causing the housing to leak water.

Composite head lamps have a polycarbonate lens, which is very sensitive to a variety of chemicals. Contact with certain chemicals can cause crazing, softening or cracking of the lens, which would require replacement of the entire lamp housing. The following chemicals are suspected to cause similar results. Mild soap and water is recommended for the cleaning of your lamps.

DO NOT USE THE FOLLOWING TO CLEAN THE HEAD LAMP LENS:

- | | |
|-------------------------------|----------------------------|
| Acetone | Liquid Cleaner - 8211 |
| Agitene® | Liquid Detergents |
| Benzyl | Lysol® |
| Carbon Tetrachloride | Oils |
| Chlorinated | Pink Lux® (phosphate free) |
| Citrus Orange Cleaners | Stanisol Naphtha® |
| Corrosive or Caustic Cleaners | Texiz-8006, 8129, 8757 |
| Diversol® | Tricholor |
| Gasoline | Triclene® |
| Kleenol Products | Toluol |
| Lemon Joy® - Phosphate Free | |
| Lestiol® | |

 **Note:** Damage to the lamp assembly by these chemicals is not covered under the manufacturer's warranty.

To prevent injuries and damage, comply with any instructions provided by the bulb manufacturer.



Whenever working on any electrical system, switch off the electrical accessory you are working on or refer to the electrical system section of your owner's manual. Failure to do this could result in short circuits.



When replacing the halogen bulb do not touch the glass portion of the bulb with your bare hands since even small amounts of impurities burn into the surface and reduce the service life of the bulb. Use a clean cloth, paper napkin, or similar material to hold the bulb during installation. With most bulbs you will not need to touch the glass part to install the bulb.







The exterior of your motorhome is made of pre-finished aluminum and fiberglass. Wash it frequently with a warm water, mild detergent and a soft rag. Take care to avoid spraying water directly into refrigerator and furnace vents when washing the motor home.

FIBERGLASS

If you travel roads that have been salted for ice, wash your motorhome as soon as possible. The most common causes of corrosion are accumulation of road salt, dirt, and moisture in hard to reach areas under the motorhome. Make sure you wash the undercarriage and wheel wells as well as the exterior of the motorhome. A good automotive cleaner may be used occasionally to remove tree sap, road tar, insects and industrial pollution that may damage surfaces. Do not use naphtha or turpentine. We recommend that you wash your motorhome about every three weeks.

It is important to note that any finish will deteriorate with time. Dulling, fading and yellowing will be increased by exposure to extreme sunlight, air pollutants, and excessive moisture. Motorhomes located in warmer weather climates are more prone to this type of premature fading. Surface weathering of fiberglass does not change the strength of the fiberglass. Regular washing and waxing of exterior surfaces is the best insurance against surface deterioration. If deterioration has occurred, check with your dealer for the steps required to restore the finish. Buffing or even painting may be necessary in extreme cases. Small cracks known as gel coat crazing are a common characteristic of the gel coat finish and not warrantable defects.

Wax fiberglass surfaces at least once a year with a standard liquid or nonabrasive paste wax. Make sure to follow the directions for use as outlined by the product manufacturer. Make sure to wash and wax your unit out of the hot sun when the exterior surfaces are cool. Storage of the recreational vehicle out of direct sun is also a primary way to help preserve fiberglass finishes. Physical damage to fiberglass should be taken care of immediately to avoid moisture from entering through breaks and causing problems with interior walls and components. Cover breaks in the fiberglass with plastic, sealing the edges with tape until proper repairs can be made.

-  **Note:** **DO NOT** use rubbing compound or any abrasive cleaner or cloth on the motor home. If using a tar and insect remover, make sure it is safe for use on painted surfaces and decals.
-  **Note:** The exterior painted finish on the motor home is of the finest quality. Proper maintenance will assure a long lasting durable finish. **Do not wax or polish the exterior for the first 60 days.**
-  **Note:** DO NOT dry wipe the surface; clean only with water and liquid detergent.
-  **Note:** DO wax the sidewalls using nonabrasive automotive waxes or cleaner/polishes developed for use on fiberglass boats, showers, and tubs. Follow the directions on the package.

EXTERIOR GRAPHICS/PAINT

Proper care and maintenance of vinyl graphics or paint is critical in maintaining its appearance. The following cleaning and maintenance recommendations should be followed to ensure the maximum appearance and performance of your vehicle's custom designed finish:

When washing, flush the surface with water to loosen large particles of dirt and grime.

Fill a bucket with warm water (not to exceed 120 degrees F. (120°F)) and use a mild detergent or a liquid car wash mixture. Follow manufacturer instructions on the container.

Using a clean soft cloth or sponge and the liquid car wash mixture, wipe the entire surface, using horizontal motions until it is clean. Rinse off the detergent with clean water starting from the top and rinse downward until it is clean.

Dry your vehicle with a clean soft cloth or let the vehicle air dry.

When waxing, ALWAYS use an automotive grade nonabrasive wax and cleaner. Use EXTREME care when waxing your vehicle and ALWAYS rub in horizontal motions.

DO NOT use a pressure washer.

It is strongly recommended that you DO NOT use a rotating brush car wash as it can lift the ends of your vinyl graphic or scratch your paint finish.

DO NOT use alcohol, strong solvents, bug remover, or tar remover on your painted or vinyl surface as it may leave a foggy appearance in that area.

 **Note:** If using a tar and/or insect remover is absolutely necessary, insure it is safe for painted surfaces and decals.

Minimize any fuel contact with your paint finish or vinyl graphics. Prolonged contact can damage the finish.

Power buffers ARE NOT recommended.

- Avoid parking under trees or near ocean salt spray.
- Ice or snow should not be scraped from the painted surface. Brush off.
- If the vehicle sits more than 24 hours, remove any front protective covering (bra) while not being driven.
- Commercial washes should be avoided. Wash with cold water using a mild liquid soap. Dry wiping with a dry cloth is not recommended.
- When driving, avoid gravel roads.
- Anti-freeze, gasoline, or window solvent spilled on painted surfaces should be rinsed off with water immediately.
- Rinse off bugs and bird droppings daily with water.

Do not use petroleum solvents, harsh abrasives, or citric based cleaners.

 **CAUTION**

Any exterior finish will deteriorate with time. Dulling and fading can be increased by prolonged exposure to extreme sunlight, air pollutants, and excessive moisture. Surface weathering of fiberglass will not diminish structural integrity. Regular monthly washing and polishing of exterior surfaces is the best insurance against surface deterioration such as fading, yellowing, or chalking. Take care to avoid spraying water directly into refrigerator and furnace vents when washing the motor home.

If surface deterioration is apparent, contact a Thor Motor Coach dealer for assistance with finish restoration. Physical damage to the fiberglass, such as cracks, holes, and chips, must be attended to immediately to avoid moisture from entering and causing problems with interior walls and components. Cover these areas with plastic, sealing the edges with tape until proper repairs can be made.

Clean and wax all trim extrusions when waxing the recreational vehicle sidewalls, to help avoid surface pitting. Special aluminum cleaners are available to restore the original luster to aluminum surfaces. Make sure to follow the instructions for use as outlined on the product package.

Inspect the roof components at least twice a year to make sure that all the seals are not cracked or worn. Proper maintenance of seals is necessary to keep moisture from entering and causing severe damage such as rot, mold, or mildew. If you encounter drying, cracked, or weathered seals, make sure to reseal as necessary. Remove the old worn seals first before reapplying the new seals. Check with your dealer for the

Precautionary Measures

EXTRUSIONS AND ALUMINUM SURFACES

ROOF

ROOF VENTS

**SEALS &
ADHESIVES**

type of caulking required for thermoplastic polyolefins (TPO) roofs and the correct methods of resealing. Silicones and synthetic sealers cannot be used on the rubber roofs. Special sealers are also required for the skylights. Your Thor Motor Coach dealer may perform the periodic roof seals for you if desired.

It is especially important to check the seals before and after periods of extended storage or non-use. Fall and spring inspections are recommended. Check the membrane for possible damage and check all accessories and fasteners. The roof may be cut or punctured by sharp objects so care must be taken when parking and driving. If damage does occur, the roof may be patched. Check with your dealer for additional information. Parking in areas where fruits, nuts or tree sap may stay on the roof for extended periods of time may result in irremovable stains.

For Normal Cleaning:

- Use a mild laundry detergent.
- Rinse the complete roof with clean water to remove any loose dirt or debris.
- Use a medium nylon bristle brush along with your selected cleanser mixed with water and scrub the entire roof. Rinse thoroughly with clean water to avoid residue buildup on the roof or sidewall of the unit.
- For more difficult stains contact your Thor Motor Coach dealer for the correct heavy duty cleansers. Do not use general-purpose cleaners containing petroleum solvents, harsh abrasives, or citric based cleaners.

If your roof should somehow be punctured, cover the puncture to seal out moisture, and have it repaired as soon as possible (check with your dealer).

The membranes used on the roof may have an extended warranty that is covered by the membrane manufacturer. This is for manufacturing defects only and does not include leaks or punctures due to improper sealing, normal wear and tear, or owner damage. See membrane manufacturer's warranty for details.

Check roof vents regularly for debris that may block air flow or jam the cranking mechanism. Lubricate the cranking mechanism with light oil.

Failure to maintain seals through regular maintenance can lead to damage of motor home components, and may be considered abusive treatment under terms of your motor home warranty.

It is important to maintain the seals and adhesives of your recreational vehicle to prevent moisture from entering and destroying the components. When washing your recreational vehicle, inspect the seals for signs of drying out, cracking and wear. You should inspect and reseal, if necessary, every six months at minimum. Be aware that weather, sun, and road vibration will affect seals, causing them to dry, crack, or separate. If you are unsure what to look for, have your dealer instruct you, and also show you the correct method for renewing the seals. If you prefer, they will be able to perform seal maintenance for your convenience.



Note: It is especially important to check the seals before and after periods of extended storage or non-use. Fall and spring inspections are recommended.

- Check seals around doors, windows, vents and external seams. If a seal is cracked or dried out, it should be replaced to prevent leakage.

- Check roof seals every six months to see if they are cracked or peeling.
- Check engine covers and firewall every six months to see if they are cracked or peeled.

Your motorhome may be equipped with a slide-out room for added space and comfort. Proper care and maintenance is required to achieve the maximum performance. Follow the guidelines listed below for your slide-out.

It may be necessary to lubricate the slide assembly (rollers, slide tubes, lever assembly) once a month with light oil to prevent rust buildup. This may be required more frequently due to road spray (salt, sand, dirt, etc.).

If you park your unit for long periods of time, run the room in and out 2–3 times to keep the moving parts lubricated and the seals moving more freely.

Keep the slide room away from tree branches. Visually inspect the room and awning before retracting. Branches rubbing against the room while retracting could cause damage to the seals.

Whenever possible, wipe down the exterior walls before retracting the room to prevent water from draining onto the carpet.

The rollers under the slide room are not sealed rollers, therefore, some residue may appear on your carpet. This is a normal function, so be aware and take proper precautions. Vacuum the carpet after each extension of the slide out room.

Verify that your house batteries are fully charged before operating the room.

In areas where the hot sun constantly beats down on the motorhome, shading the tires by covering can reduce tire sidewall cracks from forming. Tire covers can be purchased at any motorhome supply store. Check your Chassis Owner's Manual for the tire rotation requirements. Due to the weight of the motorhome you should have a qualified service center rotate the tires if recommended by your chassis manufacturer.

To keep the rims of the motor home looking their best, follow these simple steps:

1. Rinse the wheel with high-pressure water to remove any debris, grit or dirt particles.
2. Use a 100% cotton cloth dipped in a mild soap solution to help remove stuck on dirt and grease.
3. Rinse the remaining soap residue from the wheel.
4. Dry the wheel thoroughly with a 100% cotton cloth.

To lubricate the elevating gear, apply a liberal amount of silicone spray lubricant to the elevating gear with the lift in the down position. Run the lift up and down a few times to distribute the lubricant over the gears.

If rotating the antenna becomes difficult, lubricating the bearing surface between the rotating gear housing and the base plate can restore operation. Any spray type silicone lubricant may be used.

Elevate the antenna and remove the set screw from the rotating gear housing. Spray lubricant into the hole and around the edges of the gear housing. Rotate the gear housing until the lubricant coats the bearing surfaces and the antenna rotates freely. Replace set screw.

Buildup of mud under the body can cause rust, and can add unnecessary weight, which

SLIDE OUT

TIRES & RIMS

TV ANTENNA

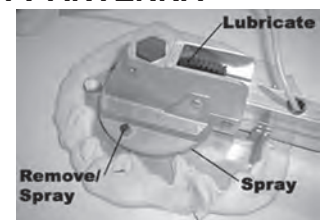

UNDERBODY

contributes to the gross weight of the vehicle. This effectively reduces the amount of cargo you can still carry and remain within your GVWR and GAWR limits.

Check the condition of the frame regularly. Keep it clean, and repaint as necessary to help avoid rust. Corrosive materials such as those used for ice and snow removal accumulate on the underside of the motorhome. These materials should be removed by flushing the underbody regularly with water, especially in areas where mud and other foreign materials collect.

WINDOWS & DOORS

Any glass will develop water spots if glass is not cleaned properly. This spotting effect is magnified when glass has a reflective finish. Use a squeegee immediately after washing to reduce water spotting. To remove stubborn water stains from reflective glass, there are several aftermarket specialty glass cleaners. The inside window track must be kept free of debris to keep the drain holes clear.

Vinyl seals around windows should be checked every six months, cleaned regularly and kept pliable by use of a silicone spray (make sure to follow the directions of the product).

Make sure that windows remain operative by adjusting and lubricating latches and moving parts annually. Also check the condition and operation of the door locks, adjusting and lubricating as necessary. Use powdered graphite or light oil to lubricate moving parts on doors and windows.

Keep screens and window slides clean and free of debris to maintain proper operation and to avoid component damage. Test the operation of all windows occasionally to make sure they are working properly, making sure that they close flush and that the locks hold tight.

Moving parts of the entrance door and lock should be adjusted and lubricated at least once a year or as needed depending on use. Screws and fasteners should be checked and tightened periodically. Check weather-stripping seals to assure proper fit and seal.

Refer to the Owner's Manual from the door manufacturer for more in-depth instructions for care and maintenance of the entrance door.



Note: Be aware that moisture can accumulate in locks and hinges of windows and doors, causing damage or faulty operation. Do not force the operation of these components in subfreezing weather.

Check with your dealer if you are unsure about the correct methods of lubrication and adjustment.

HYDRAULIC FLUID

Check fluid levels. If levels are low, take to your dealer to have the motorhome serviced by a qualified RV technician.

APPLIANCES

Make sure to read all literature provided with each of the appliances and follow the maintenance instructions included. Pay particular attention to any cautions or warnings included. Each appliance in the motor home is warranted by their respective manufacturer.

Be sure to remove all food and ice from the refrigerator at the end of each trip. Prop the doors open slightly to keep the interior dry and free of mold, mildew, and odors.

BATH FIXTURES

Clean your tub/shower, sinks, and toilets as you would at home. A nonabrasive cleaner is recommended. When cleaning mirrors or shower doors, a vinegar and water solution works very well to remove hard water spots and stains.

Inspect every 90 days and reseal as necessary. Use a clear silicone sealant.

We recommend dry cleaning for your bedspread and draperies just as you would for your draperies and comforters at home. Although this is more expensive, proper care of material will help ensure a longer life. Care of headboard and bedroom valance fabric should be done with same instructions given for upholstery fabrics. Laundering and improper cleaning may result in fabric shrinking, fading or deteriorating prematurely. Read the label on the bedspread for proper cleaning.

Professional cleaning is recommended for major cleaning. Frequent vacuuming is recommended to remove daily accumulations.

High-pressure laminate counter tops are quite easy to keep clean. Waxing is not necessary. Glass rings, food spills, water spots and smudges usually wipe off with a damp cloth or sponge. Stubborn stains can be removed with a spray cleaner. Laminated surfaces resist alcohol, fruit acids, cosmetics and most household chemicals. It is better to avoid contact with dyes, strong laundry bleaches and bluing solutions. Indelible inks used on food packages may leave a stain so take care when unpacking groceries on a damp counter top.

Sharp knives can damage the finish so confine slicing to a good cutting board. The counter top resists moderate heat and boiling water. Pots and pans straight from the oven or broiler should be placed on hot pads. Keep irons on an ironing board and lighted cigarettes in an ashtray. For lasting beauty, avoid using harsh abrasives, scouring powders, peroxides or bleaches. These can dull surfaces, making the counter top more likely to accept stains.

Wipe clean as you would for daily cleaning. Use a nonabrasive cleaner to avoid damaging the finish.

To clean, wipe with a soft damp cloth. Warm water will remove dry water spots. Do not use cleansers which contain abrasive or harsh chemicals. Never use alcohol or other organic solvents.

Keep your blinds looking new by wiping with a soft cloth. Vacuum shades regularly. Use a mild detergent to spot clean if necessary. Close the blinds and shades all the way to properly clean inside and out.

Clean with hot soapy water or a good liquid cleaner. Avoid using abrasive cleaners. Never use steel wool on stainless steel, since the steel particles left in the sink can rust and become unsightly. Also, when cleaning stainless steel with a mild cleanser, rub gently with the grain, and rinse well. Rinse after each use and wipe dry.

Preserve the luster by cleaning with a damp cloth and any household detergent designed for that purpose. To remove most stains, hard water deposits, cigarette burns and minor scratches use an abrasive cleanser or an abrasive pad such as 3M ScotchBrite brand green "Kitchen Scrub" pads. To remove deep stains and scratches use fine sandpaper (120 - 220 grit), then sand using (in the following order) 320, 400, and 600 grit sandpaper to restore the standard finish. A satin sheen or high polish can be obtained with polishing compounds.

Certain chemical substances can seriously mar surfaces even during brief periods of contact. If spilling occurs, wipe area off immediately, and then rinse with water. Potentially harmful compositions include: Toilet bowl cleaners, rust removers, contact adhesive solvent, ceramic cook top cleaners, paint or varnish removers, drain cleaners, metal cleaners, tile cleaners, lacquer thinners, or oven cleaners. Contact the manufacturer should you need further assistance.

BATHTUB SEAL

BEDSPREAD & DRAPERIES

CARPET

HIGH PRESSURE LAMINATE COUNTERTOP

HARDWARE

KITCHEN FIXTURES

BLINDS & SHADES

SINKS

SOLID SURFACE COUNTERTOP

UPHOLSTERY & FABRICS

Your RV is a small living area so soiling may occur more frequently and items will need more attention than your furniture at home. Please follow these guidelines for cleaning your upholstered fabrics:

- Clean with mild soap and water. Air dry.
- Remove tougher stains with mild detergent or mild cleaning agent like Fantastic® or Formula 409®.
- Disinfect with 5:1 bleach solution.
- Do not use abrasive cleansers.

Your upholstery fabrics have been manufactured with the same quality you would expect to find in a furniture store. However, they are not completely resistant to possible damage. Special care is needed when your motorhome is exposed to very humid, or very hot climates or if it is closed up for an extended period of time. If you know you are going to be away, cover upholstery and make sure window coverings are closed to protect upholstery from any sun damage.

WALL COVERINGS

Your decorative wall coverings are not much different from wallpaper that you may have in your home. They should be cleaned with mild soap and water. They can easily be maintained with proper care.

PRE-FINISHED PANELS AND WOOD SURFACES

Treat cabinetry and wood surfaces as you would any fine furniture product in your home. Proper care and maintenance of wood products will keep them looking like new for many seasons of use.

Clean pre-finished panels with a spray-type furniture polish. Avoid getting wood surfaces wet. Wipe off and dry immediately if this occurs. Do not use abrasive cleansers around wood finishes. Clean regularly with a soft cloth and cleaner designed for wood products such as lemon oil or any oil based wood cleaning product. Avoid constant exposure to direct sunlight which can cause fading and drying of wood surfaces.

MOLD

Molds are microscopic organisms that naturally occur in virtually every environment, indoors and out. Outdoors, mold growth is important in the decomposition of plants. Indoors, mold growth is unfavorable. Left unchecked, molds break down natural materials, such as wood products and fabric. Knowing the potential risks is important for an owner to protect their investment.

Factors Contributing to Mold Growth

According to the Center for Disease Control, exposure to damp and moldy environments may cause a variety of health effects, or none at all. Some people are sensitive to molds. For these people, molds can cause nasal stuffiness, throat irritation, coughing or wheezing, eye irritation, or, in some cases, skin irritation. People with mold allergies may have more severe reactions. Immune-compromised people and those with chronic lung illnesses, such as obstructive lung disease, may get serious infections in their lungs when they are exposed to mold.

For mold growth to occur, temperatures, indoor or outdoors, must be between 40 degrees and 100 degrees Fahrenheit and also have a source of moisture, such as humidity, standing water, damp materials, etc. Indoors, the most rapid growth occurs with warm and humid conditions.

By controlling relative humidity, the growth of mold and mildew can be inhibited. In warm climates, use of the air conditioner will reduce the relative humidity. Vents are located in the bathing and cooking areas and constant use is advised during food preparation and bathing, even during colder weather. Additionally, opening a window during these activities will assist in ventilation. In extremely humid conditions, the use of a dehumidifier can be helpful.

 **Note:** If using a dehumidifier, please read and follow all manufacturer instructions and recommendations to the use and cleaning of the dehumidifier.

Ideally, relative humidity should be at 60% or less. Relative humidity can be monitored utilizing a portable hygrometer, a small device that measures temperature and relative humidity. Hygrometer's are available at electronics or building supply stores for minimal cost.

 **Note:** In cold climates, relative humidity may need to be at 35% or less to avoid window condensation.

Frequent use of the motor home or cleaning regularly is an important preventive measure. Further, any spills should be wiped up quickly and dried as soon as possible. Avoid leaving damp items lying about. On safe surfaces, use mold or mildew killing cleaning products. Check sealants regularly, and reseal when necessary to avoid water leaks. Proper preventive maintenance to the motor home and its accessories, as described both in this manual and in accompanying.

Your motor home was designed primarily for recreational use and short-term occupancy. If you expect to occupy the motor home for an extended period, be prepared to deal with condensation and the humid conditions that may be encountered. The relatively small volume and tight compact construction of modern motor homes mean that the normal living activities of even a few occupants will lead to rapid moisture saturation of the air contained in the motor home and the appearance of visible moisture, especially in cold weather.

Moisture can condense on the inside surfaces of the motor home during cold weather when relative humidity of the interior air is high. Insulated walls of a motor home are much thinner than house walls. Estimates indicate that a family of four can vaporize up to three gallons of water daily through breathing, cooking, bathing, and washing. Unless the water vapor is carried outside by ventilation, or condensed by a dehumidifier, it will condense on the inside of the windows and walls as moisture, or in cold weather as frost or ice. It may also condense out of sight within the walls or the ceiling where it will manifest itself as warped or stained panels. Appearance of these conditions away indicate a serious condensation problem. When you recognize the signs of excessive moisture and condensation in the motor home, action should be taken to minimize their effects.

 **Note:** Your motor home is not designed, nor intended, for permanent housing. Use of this product for long term or permanent occupancy may lead to premature deterioration. Long-term occupancy may not be considered normal, and may under the terms of the warranty constitute misuse, abuse or neglect, and void certain warranty protections.

Inhibiting Mold Growth

Effects of Prolonged Occupancy

Tips for Controlling Condensation

To avoid condensation problems, try to follow these tips to help alleviate excess moisture:

- Allow excess moisture to escape to the outside when bathing, washing dishes, hair drying, laundering, and using appliances and non-vented gas burners.
- Always use the vent hood when cooking.
- Keep the bathroom door closed and the vent or window open when bathing and for a period of time after you have finished.
- Do not hang wet clothes in the vehicle to dry.
- In hot weather, start the air conditioner early as it removes excess humidity from the air while lowering the temperature.
- Keep the temperature as reasonably cool during cold weather as possible. The warmer the vehicle, the more cold exterior temperatures and warm interior temperatures will collide on wall surfaces, thus creating condensation.
- Use a fan to keep air circulation inside the vehicle so condensation and mildew cannot form in dead air spaces. Allow air to circulate inside closets and cabinets (leave doors partially open). Please keep in mind that a closed cabinet full of stored goods prevents circulation and allow the exterior temperature to cause condensation.
- The natural tendency would be to close the vehicle tightly during cold weather. This will actually compound the problem. Simply put, you need to remove some of the warm air, and allow some cool outside air to get inside the vehicle, so the furnace will not recycle the humid interior air.
- Use fluorescent ceiling lights and minimize prolonged use of incandescent lights, which produce heat and contribute to condensation in the roof above the ceiling lights.

Avoid Drastic Thermostat Setbacks

Cooler surface temperatures increase the potential for condensation and surface mold growth. To minimize the opportunity for condensation to form on interior surfaces, maintain a comfortable temperature in the motor home, and avoid nighttime setbacks of 10° or more. Drastic setbacks that reduce the indoor air temperature quickly can increase the chance for airborne moisture to condense on cool surfaces such as windows. If you are away from the motor home for an extended number of days, we recommend that you do not set the temperature back without taking other measures to manage relative humidity, including operating a dehumidifier with a continuous drain.

Carpet Care And Moisture Management

The carpet should be cleaned when it shows signs of discoloration or traffic patterns. The use of a professional steam cleaning system is recommended for cleaning the carpet, unless otherwise noted. To manage moisture from the cleaning process, the cleaning system needs to be capable of extracting the excess water from the carpet after it has been cleaned. Important: Be sure the carpet is thoroughly dry before closing the motor home for storage. Water from the cleaning process can cause significant damage to the motor home if the carpet is not completely dry before closing up the motor home for an extended period.

Exterior Care of the Motor Home

The exterior shell of the motor home is the primary weather and moisture barrier. Over the life of the motor home, the shell will require regular care and maintenance. The shell includes the roof, sidewalls, windows, doors and under carriage of the motor home. Particular attention needs to be devoted to ensure these components are maintained to ensure a tight barrier against bulk water intrusion.

The shell should be inspected periodically for tears, gaps, and condition of sealants. Areas that require maintenance should be resealed utilizing a proven, high quality sealant of similar characteristics as the original sealant. Particular attention should be

devoted to ensure the slide outs are functioning properly. Each time a slide out is used, it should be inspected to ensure proper operation and sealing. The slide out gaskets should also be inspected to ensure proper sealing when the slide out is operated.

During those periods when the motor home is not in use, care must be taken to ensure moisture sources are addressed. Ideal storage of the motor home would be in an enclosed climate controlled environment. When this is not possible, the following steps should be taken to ensure moisture is controlled:

- Turn off all water sources.
- Turn off all combustion appliances.
- Drain all holding tanks.
- Drain the water heater.
- Open all closets, cabinet doors and drawers.
- Close all windows and entrance doors.
- Open a vent enough to allow for some limited ventilation air flow, but not so far as to allow snow or rain to enter.
- When storing the motor home high humidity climates (ambient relative humidity is greater than 60% year round), add a dehumidifier drained to the exterior to control humidity inside the recreational vehicle during storage.

Areas that are exposed to water spills or leaks should be dried as soon as possible and definitely within 24-48 hours. Drying areas quickly minimizes the chance for moisture damage and possible mold growth, which can begin to form colonies in 48 hours. A variety of methods can be used to help the drying process:

- Remove excess water with an extraction vacuum.
- Use a dehumidifier to air drying.
- Use portable fans to move air across the surface.
- Because moisture is key to mold issues, treat all signs of condensation and spills seriously and deal with promptly. Failure to deal with a moisture issue promptly may cause more severe issues where none initially existed, or may make a small problem much worse.
- Learn to recognize signs of mold - don't paint over or cover up suspicious discoloration until you are sure it is not mold. The affected surface must first be cleaned and dried; residual staining may be painted.
- Be sure to understand and eliminate the source of moisture accumulation as a part of the clean-up.
- Small amounts of mold should be cleaned as soon as it appears. Small areas of mold should be cleaned using a detergent/soapy solution or an appropriate household cleaner. Gloves should be worn during cleaning. The cleaned area should then be thoroughly dried. Dispose of any sponges or rags used to clean mold.

Storage of the Motorhome

Winter Use and Storage

Many people choose to use their motorhomes throughout the entire year. Extensive usage is not recommended in severe cold weather. However, winter traveling can be safe for you and your motorhome if you follow the precautions outlined in this chapter. For those who choose to use their motorhomes only during the warmer months, winter storage is necessary. This section will guide you through the proper steps to winterize your motorhome, which is critical to maintain maximum durability over the life of your vehicle.

The fresh water storage tank is located inside a lower storage compartment. The furnace will heat the fresh and waste water compartments. In severe cold however, it is wise to monitor the water temperature in the tank, and take appropriate steps to drain and winterize if necessary. In severe cold weather, it may also be necessary to open the lower cabinet doors at night in both the bath and kitchen areas to keep warmer air circulating around the water fixtures.

If you are going to leave the coach unheated for any length of time in severe cold conditions, it is best not to keep water in the fresh water system. It may work best to carry cooking and drinking water with you in plastic jugs instead.

If you will be using your motorhome when conditions fall below the freezing level, it may be necessary to protect the drainage system components from damage by the addition of an approved antifreeze solution as outlined on the product directions. Any drain lines exposed to external air temperatures are especially susceptible to freezing and precautions should be taken to protect them from damage.

In the event that the motorhome is left for a period of time without the furnace in operation, canned goods and other foods packed in water should be stored as high as possible, since heat rises. They might also be stored in the refrigerator as insulation against the cold. Store dry foods, and other items that are not damaged by freezing temperatures in the lower storage areas.

Make sure to use propane that will vaporize properly in the colder temperatures. Check with your propane representative for the proper fuel.

Use only the furnace to heat the recreational vehicle. It is properly vented to the outside.

Never use the range for heating as carbon monoxide may build up inside the unit and asphyxiation could result.  **WARNING**

Cooking produces large amounts of moisture, not just as steam from pots and pans, but also as a product of combustion. Make sure to use the exhaust vents and open a window slightly to control the humidity. At night, leave a roof vent and/or a window slightly open.

When a motorhome is exposed to freezing temperatures, it could be severely damaged by ice expansion. This is especially true of the water heater, washer/dryer, ice maker, holding tanks, and faucets, which are at risk for damage if not properly drained during the winter. All water must be drained from the motorhome. The procedure to do so is as follows:

1. Drain the fresh water tank by opening the low point drain valve. Let the water drain out until the tank is empty.
2. Drain both the black (waste) water tank and the gray (sink) water tanks and flush out completely. Drain the black tank first and allow the gray water tank to rinse out the flexible hose drain line. You may now add a commercial holding tank chemical cleaner. Driving the unit around for a few miles will allow the cleanser to circulate

TIPS FOR WINTER USE

WATER SYSTEM

FOOD STORAGE

PROPANE SYSTEM

HEATING

CONDENSATION

WINTERIZATION PROCEDURE

Winter Use and Storage



Water Heater Drain Plug

within the tanks and drains. Drain and flush once more with fresh water.

3. After all the tanks have been drained, make sure that any water remaining in the lines is either blown out, or replaced with a nontoxic RV antifreeze solution which will prevent any water that remains from freezing. To blow out the water lines, proceed as follows:
4. Open all faucets including the toilet flushing device and the shower head sprayer. Open any other water lines that are closed. You will need access to an air compressor along with an adapter that will connect the air to your unit. These adapters can be purchased at an RV supply store. Do not exceed 55 psi when hooked up to the water lines to avoid damage. If your vehicle is equipped with a water filter, remove and drain it before proceeding. Replace it with a diverter tube, which will come with the unit. This will create a bypass in the water line so that the antifreeze will not go into the filter assembly.
5. Turn on the water pump and allow it to run to clear all water from lines. Turn off the water pump.
6. Open all low point and water tank drains.
7. Open the water heater cover and remove the water heater drain plug located on the lower front side of the water heater (see photo).
8. Hook an air hose to the city water connection located in the termination compartment. Blow out the water lines (do not exceed 55 P.S.I.) until no more water can be seen coming out of the lines. Pause for several seconds and repeat until clear.
9. Put nontoxic RV antifreeze in the drains, p-traps, and water tanks.

If you do not have access to an air compressor, you may use the “wet” method of winterization:

After you have completely drained all the tanks, water heater and lines by opening the low point drains and switching the water heater bypass valves to the bypass position, close the low point, water tank and the water heater drains.

Pour 4-6 gallons of RV antifreeze into the fresh water tank and let the water pump circulate the mixture. Do not dilute. Open the furthest faucet or water valve from the pump and work your way through the entire system. Turn on one (hot and cold) at a time until the antifreeze solution is observed, then close the valve. Allow at least 2 cups to pass through for complete protection. Make sure to include all water lines such as showers and tubs, toilet, washing machines, dishwashers, ice makers and outside shower faucets. The antifreeze should be left in the sink, washer and shower p-traps and toilets during storage to protect those lines. Open all faucets one half way to relieve pressure on the valve seats during storage. Wipe all fixtures clean to prevent staining.

⚠ WARNING

Antifreeze must be nontoxic in nature and must be flushed from the fresh water system before human use. Automotive antifreeze is poisonous and SHOULD NOT be used in drinking water systems.

Draining the tanks and water lines in your motorhome is half the battle of winterization. Complete the Storage and Winterization Checklist to ensure protection of your

motorhome. An authorized Thor Motor Coach service dealer can help you in the winterization process for your convenience.

A water heater bypass valve system is located inside your motorhome usually behind the water heater. When the system is closed, water is shut off to the water heater. This will eliminate circulating an additional six to ten gallons of antifreeze through the water heater system when winterizing the system. Be sure to remove the drain plug from the outside of the water heater to drain the water heater tank.

WATER HEATER BYPASS

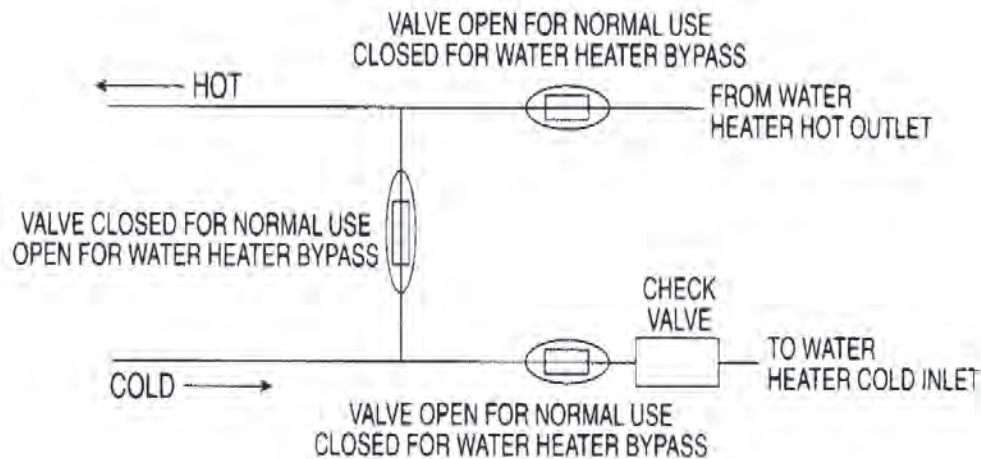

to talk with your local dealer concerning any special requirements for storage in your particular geographic area. The following steps are general, and your dealer can help you choose those that are most appropriate for your needs.

WINTERIZATION CHECKLIST

Chassis	Run engine for 30 minutes once a month if possible. Prepare as outlined in the Chassis Owner's Manual.
Generator	Prepare as outlined in the Generator Owner's Manual.
Plumbing Lines	Drain and protect by filling with approved RV antifreeze. Drain.
Water Heater	Drain. Hold pedal down and pour RV antifreeze into bowl.
Toilet	Drain, pour RV antifreeze solution and run through the fresh water system, or use the dry method.
Fresh Water Tank	Remove and discard the filter. Install diverter tube in place of filter assembly.
Body	Clean and wax. Oil locks and hinges. Seal roof trim as needed.
Tires	Block up motorhome with wooden blocks or manufactured jack-stands on a hard level surface to relieve the constant pressure on one area of the tires. Partially deflate the tires. Cover to protect against sunlight with burlap, plywood or specially designed tire covers which are available at RV dealerships.
Countertops & Cabinets	Wash with mild soap and water.

Winter Use and Storage

Curtains & Blinds	Close all the drapes and curtains, and protect the curtains from sun fading by placing foil or paper between the windows and the curtains/blinds.
Windows	Close and lock. Inspect and reseal if necessary.
Holding Tanks	Drain and rinse. Close valves. Add a small amount of RV antifreeze to keep valves and gaskets lubricated.
Drain Traps	Pour a cup of RV antifreeze down all drains. Wipe all fixtures clean.
Refrigerator	Clean. Leave both doors propped open. Cover exterior panels and roof vents. Leave an opened box of baking soda inside the refrigerator to prevent any musty odors from accumulating.
Ice Maker	Refer to your refrigerator owner's manual for proper winterization procedures.
Air Conditioner	Remove air filters and clean or replace. Cover shroud.
Roof	Must be kept clear of significant snow accumulation or damage may occur. Inspect and reseal if necessary.
Vents	Check all furnace, refrigerator, range hood, A/C, etc. vents and close securely. Cover or tape up to prevent mice or insects from building nests that can disturb the air flow and keep the appliances from functioning properly.
Sinks & Showers	Clean and then pour one cup of nontoxic RV antifreeze into the drains to prevent freezing. Wipe all fixtures clean.
Batteries	Add distilled water and recharge if necessary. If possible, remove batteries and store them in a cool dry place (approximately 50 – 60° F). Check them periodically and recharge as needed. Be sure that both the chassis and auxiliary (house) batteries have the proper electrolyte level and that they are fully charged. A discharged battery will freeze and may crack the case, causing severe damage to the battery and surrounding area. In storage, a battery will lose charge gradually over a 30 to 45 day period, even when disconnected by the use of the Battery Disconnect Switch. We recommend that the batteries be checked for charge at least monthly. You may wish to remove the batteries from the motorhome and store them in a heated area. However, even when warm, the battery charge level must still be maintained. A warm battery accepts charge much more readily than a cold one.
⚠ WARNING Keep the battery vent caps in place during storage and prohibit smoking, welding, and other work involving the use of flames in the area.	
Fuel	Store with the tank full to prevent condensation buildup.
Dash	Run for a short period of time to assure the compressor seal is lubricated.
Air Conditioner	
Interior	Check the interior of the motorhome monthly while in storage to make sure leaks have not developed, or condensation has not formed that can cause damage to interior components. Condensation can most readily be observed as moisture accumulation on windows and mirrors. To reduce condensation, make sure to air out the motorhome occasionally during storage.

Travel Preparation Checklist

CLOTHING

Dresses
Gloves
Hat or Cap
Jackets, Coats
Jeans, Dress Pants
Pajamas
Shirts, Blouses
Shoes, Sandals
Shorts
Socks
Sweaters
Swimsuits
Undergarments

TOOL CHEST

Electrical Tape
Step Ladder
Furnace Duct Tape
Hatchet
Masking Tape
Saw
Shovel, Rake
Small Level
Tire Pressure Gauge
Various Tools

HOUSEKEEPING

Dish Cloths, Dish Towels
Dish washing Soap
Disposable Gloves
Garbage/ Trash Bag
Mop, Broom, Dust Pan
Paper Towels
Surface Cleaner, Degreaser
Throw Rug
Trash Cans
Vacuum Cleaner

SAFETY

Compass
First-Aid Kit
Flares
Flashlights
Reflectors

SLEEPING GEAR

Blankets
Pillows, Pillow Cases
Sheets
Sleeping Bags

PERSONAL COMFORT

Anti-Bacterial Wet Wipes
Ash Tray
Personal Medications
Personal Toiletries
Sewing Kit, Scissors
Soap
Sunscreen
Toilet Paper
Toothbrush, Toothpaste
Towels, Wash Cloths

MEAL PREPARATION

Baking Pans
Bottle Opener, Can Opener
Coffee Maker
Foil, Plastic Wrap
Glasses, Cups
Plastic Containers
Plates, Bowls
Portable Grill
Pots, Pans, Skillets
Salt & Pepper
Seasonings, Spices
Silverware, Spatulas, etc.
Toaster

ENTERTAINMENT

Binoculars
Books, Magazines
Camcorder
Camera, Film, Memory Card
Movies
Music/Cd's
Toys, Games, Playing Cards
VHS Player, DVD Player
Yard Games

MISCELLANEOUS

Alarm Clock
Batteries
Bucket
Clothes Hangers
Clothes Line, Clothes Pins
Electronics Chargers
Fresh Water Hose
Fuses
Ground Extension Wire
Umbrella
Wheel Chocks
Y-Type Water Hose Fitting

CAMPFIRE COMFORT

Bug Repellent
Bug Zapper
Charcoal
Enclosed Screen Tent
Firewood
Grill
Matches
Picnic Table Cloth w/ Clips
Yard Chairs

PET COMFORT

Food & Water Dish
Leash
Litter
Litter Box
Pet Food
Portable Cages
Scoop w/ bags
Screw Stake for tie out
Tick Repellent
Tie Out Cable
Toys

OTHER

Maintenance Schedule

ITEM	EVERY TRIP	EVERY MONTH	EVERY 3 MONTHS	EVERY 6 MONTHS	EVERY YEAR	PRIOR TO STORAGE	AS REQUIRED	PROCEDURE TO BE PREFORMED: Maintenance schedules are minimum requirements. Heavy use, unusual temperatures or humidity, or other extreme conditions may require more frequent maintenance.
Roof & Components				x		x	x	Inspect & reseal roof & exterior attachment areas.
			x					Clean roof.
					x		x	Lubricate roof vent mechanism w/ light oil. Clean as needed.
Fiberglass Exterior		x						Wash w/ warm water & mild detergent.
					x			Wax w/ liquid or nonabrasive wax.
Windows & Doors		x						Check vinyl seals when washing exterior.
			x					Check seals for damage & repair as needed.
			x					Lubricate door hinges & step components w/spray grease.
					x			Adjust & lube w/ graphite or light oil.
					x			Lubricate door locks & strike pockets, exterior components.
Seals & Adhesives		x						Inspect and reseal if necessary.
Propane System					x		x	Check for leaks and damage.
					x			Check line pressure; should be checked by technician.
Water System		x						Check hoses, fittings & connections for leaks.
	x							Check drainage system for leaks.
					x	x	x	Sanitize & flush system.
					x			Winterize system if necessary.
Electrical System		x						Check GFCI circuits.
							x	Perform maintenance procedures per generator manual.
							x	Check & service batteries.
							x	Add distilled water to batteries if necessary.
Safety Equipment	x							Test propane, smoke, CO detectors.
	x							Test & check fire extinguisher.
Carpet	x							Vacuum after every trip.
							x	Shampoo as needed.
Front Wheel Alignment							x	Inspect and align as needed.
Seats							x	Lubricate mechanisms & inspect for proper operation.
							x	Check all seat belt buckles, webbing & releases.
Chassis & Components							x	Per chassis manufacturer manual.
	x							Check fluid levels including: oil, brake, washer, engine coolant, transmission, battery water, etc.
Power Step			x					Clean & lubricate with spray lithium grease.
Weight & Distribution	x							Check for proper weight distribution per specifications.
Fabrics & Upholstrey							x	Clean per manufacturer's specifications.
Tires	x							Inspect for wear & proper inflation.
	x							Check all wheel lug nuts and tighten per chassis specifications
Appliances							x	As required by appliance manufacturer.

Index

12V System Fuses	80	Doors & Drawers	18,58
12V System Fuses - Automotive	80	Driving	41
12V System Fuses - Interior	80	Dumping the Holding Tanks	89
30 Amp Shore Power	76	Effects of Prolonged Occupancy	109
50 Amp Shore Power	76	Egress Window	34
ABS Plastic Parts	99	Electric Slide Out	54
Air Hide-A-Bed Sofa	58	Electric Slide Out Manual Retraction Procedure	54
Alignment	13,99	Electric Step	63
Appliances	106	Electrical System	75,98
Assist Handle	62	Elevated Beds	61
Attic Fan - Create A Breeze	74	Elevated Beds - Tips for Safe Usage	61
Attic Fan - Fantastic Vent	73	Emergency Retraction Procedure	52
Automatic Hydraulic Power Levelers	50	Emergency Stopping	37
Automatic Leveling and Retraction Procedure	50	Engine Access	38
Automatic Patio Awning	65	Engine and Drive Train	37
Automotive Dash	45	Entertainment	68
Auxiliary Battery	97	Entry Door	62
Awning	65,99	Entry Step	18
Barrel Chair	58	Exhaust Vent	73
Bath Fixtures	106	Exterior Care of the Motorhome	110
Bathtub Seal	107	Exterior Checks	39
Batteries	13,76,97	Exterior Entertainment Center	68
Battery Charging	79	Exterior Graphics/Paint	102
Battery Isolator Controller	78	Exterior Lights	100
Battery Maintenance	77	Exterior/Interior	13
Battery Replacement	13	Extrusions and Aluminum Surfaces	103
Battery Safety	76	Federal Weight Label	20
Bedroom Door & Latch	59	Fiberglass	101
Bedsprad & Draperies	107	Fire Extinguisher	26
Blinds & Shades	107	Fire Safety	26
Cable Hookup/Phone Jack	66	Food Storage	113
Camera Operation	48	Ford Fuel Pump Collision Shut-off Switch	38
Carbon Monoxide Detector	27	Formaldehyde	32
Carbon Monoxide Safety Precautions	29	Fresh Water System	85,98
Care and Maintenance	97	Fresh Water System - External Hook-up	85
Carpet	107	Fresh Water Tank with Gravity Fill	85
Carpet Care and Moisture Management	110	Fresh Water Tank without Gravity Fill	86
Ceiling Vents	73	Fuel System	41
Chairs	59	Fuel/Oil Record	122
Changing Tires	42	Fueling the Motorhome	38
Chassis	37,100	Furnace	72
Chassis Alternator	82	Furnace Door	66
Chassis Battery	97	Furnace Operation Instructions	72
Chassis Checks	38	Gear Selector	45
Check Air Pressure	42	Generator	82
Checking the Propane System for Leaks	30	Generator Compartment	66
Chemical Sensitivity	32	Generator Power System	98
Child Restraints	33	Graphics and Exterior Paint - Precautions	103
Circuit Breakers	80	Ground Fault Circuit Interrupter	79
Compartment Doors & Storage Compartments	64	Hardware	107
Compartment Doors	18	Hazard Flasher Control	47
Condensation	13,113	Heated Holding Tanks	89
Control of the Motorhome	17	Heating	113
Controls and Operations	45	Heating and Air Conditioning	71
Dash A/C Control Panel	71	Hide-A-Bed Sofa	57
Dash A/C Operating Features	71	High Pressure Laminate Countertop	107
Dash A/C Warranty/Service	71	Home Theater System	68
Dash Controls	45	How to Prevent Blockage of Drain Lines	89
Dash Panel Heater and Air Conditioner	71	How to Use this Manual	7
Dash Radio	49	How to Weigh Your Motorhome	21
Day/Night Shades	59	Hydraulic Fluid	106
Dinette	58	Hydraulic Pump Function Wiring	53

Index

Identification and Safety	25	Proper Load Balance	14
Index	126	Range	60
Inspect and Maintain	17	Read the Book	17
Insurance	17	Rear Ladder	64
Introduction	7	Rear Vision System	48
InWall Slide Out	55	Rearview Mirror	18
Kitchen Cabinets	60	Refrigerator	60
Kitchen Drawers	60	Refrigerator Doors	18,66
Kitchen Faucet	61	Reporting Safety Defects	7
Kitchen Fixtures	107	Return Air Filters	72
Kitchen Pantry	60	Roof	103
Kitchen Sink	60	Roof A/C Performance Characteristics	72
Laws of the Road	25	Roof Mounted Air Conditioner	72
Licenses	17	Roof Vents	104
Lights	18	Sample A/V Hook-up Diagrams	68
Living Room Television	56	Sanitizing the System	87
Loading and Weight Distribution	17	Sealants	14
Low Point Drains	87	Seals & Adhesives	104
LP Detector - How to Test	30	Seat Belt Maintenance	33
LP Detector - Most Common Causes of Apparent Malfunction	31	Seat Belts	33
LP Detector Maintenance	30	Seatbelt Operation	33
LP Gas Detector	30	Service Calls	14
LP Safety	29	Sewage	18
LP System	93	Shore Cord	75
Maintenance Schedule	119	Shower Head & Hose	61
Major Equipment Suppliers	15	Sinks	107
Manual Dome Operation	73	Sleep Number Bed	56
Manual Override	55	Slide Out Awning	65
Manual Patio Awning	65	Slide Out Lubrication	14
Manually Closing the Automatic Awning	66	Slide Outs	54,105
Microwave	60	Smoke Detector	27
Mold	108	Smoke Detector - Choosing a Replacement Battery	28
Mold - Factors Contributing to Mold Growth	108	Smoke Detector Regular Maintenance	28
Mold - Inhibiting Mold Growth	109	Smoke Detector Testing Procedure	28
Monitor Panel	88	Sofa Bed	57
Monitor Panel - Inaccurate Readings	88	Sofa/Hide-A-Bed	57
Monitor Panel - Oversensitive Readings	88	Solid Surface Countertop	107
Monitor Panel - Tank Capacities	88	Space Saver Sofa	58
Monitor Panel - Undersensitive Readings	88	Steering Wheel Adjustment	47
Notes	124	Step Lubrications	14
On the Road Safety	41	Storage Above Cockpit	56
Opening Checklist	18	Storage of the Motorhome	111
Operational Checks	39	System Panels	81
Owner Responsibility	13	System Panels - 110V with 30 Amp	81
Parking	41	System Panels - 110V with 50 Amp	81
Planning and Preparation	17	System Panels - BCC Fuse Panel	81
Potable Tank	13	System Panels - Converter Fuse Panel	81
Power Converter	79	Television	68
Power Cord	18	Termination Compartment Components	90
Pre-Finished Panels	108	Thermostat Setbacks	110
Pre-Travel Check	17	Thermostats	73
Pre-Trip Checklist	39	Tips for Controlling Condensation	110
Production Changes	13	Tips for Winter Use	113
Propane Gas Hoses	96	Tire Care	42
Propane Gas Safety	96	Tire Pressure	14
Propane Gas Tank	93	Tires	17
Propane Regulator	94	Tires & Rims	105
Propane Regulator - Freeze-up	95	Toilet	90
Propane System	99,113	Toilet - Foot Pedal	91
Propane Tank	18	Toilet - Hand Lever	90
Propane Tank - Filling the Tank	93	Trailer Towing	34
		Travel Bars	14

THOR MOTOR COACH
P.O. BOX 1486 ELKHART, INDIANA 46515
TOLL FREE (877) 855-2867
THORMOTORCOACH.COM

